



Vídeňská 172, Vestec
252 42 Jesenice u Prahy
Czech Republic

Phone: +420-234 144 746, 790
Fax: +420-234 144 710, 777



WS ECONOMIC WS PRACTIC

**Product Specification
Instructions for Use
Maintenance**

Only worker, who was determined to operate the wrapping machine and who was provably familiarized with these instructions for use and safety rules, which are stated hereinafter, may operate the wrapping machine.

CONTENTS

1. INTRODUCTION.....	2
2. SPECIFICATION, DETERMINATION AND USE OF THE MACHINE	3
3. SAFETY INSTRUCTIONS	10
4. PUTTING INTO OPERATION.....	14
5. EQUIPMENT.....	24
6. WRAPPING	34
7. MAINTENANCE AND CLEANING OF THE MACHINE.....	52
8. GUARANTEE.....	59
9. SERVICE	60

1. INTRODUCTION

WS wrapping machines of all versions and all models are provided with safety equipment for staff protection as well as for machine protection during its ordinary use. These provisions cannot cover all risks and thus it is necessary for staff to study through and understand these instructions, before using the machine and to follow these instructions.

These instructions are designed for the users and workers, who operate and maintain **WS** wrapping machine of all models. They are written for the machine with full equipment; if your machine does not have some optional features installed, ignore its description and control.

If **WS** wrapping machine is installed and operated in accordance with this accompanying documentation, its operation is safe and the goods on the pallet is wrapped quickly, in high-quality and economically.



1.1. Conventions

Text of the instructions is written in current font, such as this paragraph.

Names of buttons and control elements are written in **BOLD SMALL CAPITALS**.

1.2. Used symbols

These symbols are used in the text:

	Danger – omission of these instructions may cause a serious injury or death or serious machine damage
	Warning against the danger of machine damage, or injury of staff or people, who are near the machine.
	Information , making the machine use easier

These instructions are the original instructions for use according to Directive EU no. 2006/42/ES and they are authorized by the manufacturer.

2. SPECIFICATION, DETERMINATION AND USE OF THE MACHINE

2.1. Use

Wrapping machines **WS ECONOMIC** and **PRACTIC** are designed for fixation of the pallet units with the stretch film. It is suitable for modest wrappings in the plants with rather small wrapping capacity. Its modular conception enables to use the machine as good as possible, corresponding to the character of the wrapped goods, quality requirements and economic wrapping.

2.2. Working Conditions of the Machine

Wrapping machine is designed for work in the environment, which has to meet the following conditions:

Normal environment in terms of IEC 364-3 on conditions mentioned hereinafter in this chapter and on the condition of installation and operation according to this accompanying technical documentation.

It is necessary to install and operate the machine in covered operating premises protected against atmospheric influences.

The floor has to be even and braced, the maximal allowed deviation of the floor flatness is $\pm 3 \text{ mm} / 2\text{m}$. It is necessary to get raw dirt, grits, etc. off the area before positioning of the machine in the place.

Temperature range for the machine operation is $+5^{\circ}\text{C}$ up to $+40^{\circ}\text{C}$, speed of temperature change max. $10^{\circ}\text{C} / 30 \text{ min}$.

Relative humidity $30\% \div 95\%$ without condensating humidity (dew).

It is possible to operate the machine only in premises, which match the requirements of national regulations for working environment.

It is forbidden to place the machine so that the width of the access paths to the electric equipment was decreased under the minimal values stated in the national regulations.

No obstructions, which can cause injury of the staff (stairs, ramps, drop ceilings other machines, etc) may be near the machine.

The product must not be used in explosive environment or in place where the explosive environment may rise even for short time.

Machine and particularly its electric equipment have to be installed and operated according to the producer's instructions stated in this accompanying technical documentation.

2.3. Design of the Machine

Design of the machine corresponds to regulations and standards mentioned in Declaration of Conformity, which is a part of this accompanying technical documentation.

Requirements of standards and regulations are included in the product documentation. User's precautions are described in this accompanying technical documentation – instructions for use.

Supposed service life of the machine is 10 years or 50 000 operation hours – what occurs earlier – on condition of use of the machine in accordance with this accompanying technical documentation and with keeping the prescribed maintenance and periodical machine check-up.

2.4. Technical Parameters

		WS ECONOMIC		
Model	Turntable	Standard 1500 mm	Standard 165mm	Standard 1800 mm
Weight (according to equipment, min.)		370 kg	390 kg	485 kg
		(see type plate)		
Wrapping height		2250 mm		
Dimensions	Height	2216 mm		
	Width	1500 mm	1650 mm	1800 mm
	Length	2350 mm	2500 mm	2650 mm
Turntable	Diameter	1500 mm	1650 mm	1800 mm
	Loading limit	2000 kg		
	Drive	el. motor 370W 3x400/230V, 50Hz		
	Revolutions	10 rev/min + 20%		
	Running direction	Right		
Drive of prestretch device		el. motor 250W 3x400/230V, 50Hz		
Weight of the wrapping film roll		c. 17 kg		
Electric connection	Operational voltage	3 x 400/230V, 50Hz		
	Machine wattage	1.5 kVA (see type plate)		
	Supply mains protection	16 A (see type plate)		
	Control circuit voltage	24 V		
	Degree of protection of electric equipment	IP 54		

		WS PRACTIC		
Model	Turntable	Forklift-shaped 1500 mm	Forklift-shaped 1650 mm	Forklift-shaped 1800 mm
Weight (according to equipment, min.)		405 kg	450 kg	500 kg
Wrapping height		2250 mm		
Dimensions	Height	2216 mm		
	Width	1500 mm	1650 mm	1800 mm
	Length	2350 mm	2515 mm	2650 mm
Turntable	Diameter	1500 mm	1650 mm	1800 mm
	Loading limit	1200 kg		
	Drive	el. motor 370W 3x400/230V, 50Hz		
	Revolutions	10 rev/min + 20%		
	Running direction	Right		
Drive of prestretch device		el. motor 250W 3x400/230V, 50Hz		
Weight of the wrapping film roll		c. 17 kg		
Electric connection	Operational voltage	3 x 400/230V, 50Hz		
	Machine wattage	1.5 kVA (see type plate)		
	Supply mains protection	16 A (see type plate)		
	Control circuit voltage	24 V		
	Degree of protection of electric equipment	IP 54		

2.5. Type Plate

Type plate is placed on the bottom part of the mast; its identical copy is protected against damage or loss by its placement in the switchboard (panel with controller) on the internal side plate of the switchboard on the left. The type plate contains the following data:

- Name and address of the producer (supplier)
- Type designation of the product
- Serial number of the machine
- Year of production
- Number of electrical scheme
- Machine weight (kg)
- Supply voltage (V)
- Supply voltage frequency (Hz)
- Protection (A)
- Machine wattage (kVA)
- Control circuit voltage (V)

Data of the type plate come before the data in technical parameters table or before other data in this accompanying documentation.

2.6. Expendable Material

The machine is designed for wrapping of goods on pallets into the stretch film from linear low-density polyethylene (LLDPE) in width of 20 µm±40. For machines provided with mechanical prestretch device, the film has to have the minimal dilatibility 150%. Manual or electromagnetic brake of the film does not demand guaranteed value of film dilatibility. The film has to be in form of rolls with width of 500±10 mm and diameter of max. 250 mm. The tube, on which the film is wrapped, has to have the internal diameter of 76±3 mm and length of 510±5 mm.

It is possible to use non-adhesive film as well as single-adhesive film. The adhesiveness of one side means that the separate layers of the film wrapped on the goods cling together very well, but they do not tend to damage the goods on the pallet. The main purpose for use of such film is better fixation of the goods on the pallet, higher solidity of the wrapping and its better resistance to climatic effects and mechanical tension during transport. After wrapping of the pallet with goods, the wrapped film has to be directed with the adhesive side inward (toward goods), thus the pallets will not be apt to cling together during manipulation with the wrapped pallets and during their transport.

By default, the film is resistant to UV radiation for 6 months, i.e. the wrapped goods may be stocked outside in this period and it may be exposed to the solar radiation, keeping all the original features of the wrapping. If longer period of stocking in the outside environment is required, it is possible to deliver some films in the design with advanced resistance to UV radiation.

The following stretch films satisfy the above-mentioned requirements:

Model	dilata- bility	use	possible variants
POWERFLEX SQ	160%	Manual or electromagnetic brake of the film. Wrapping of heavy goods with sharp edges	Various widths Non-adhesive as well as single- adhesive With advanced resistance to UV radiation
POWERFLEX PQ	200%	Mechanic prestretch device. Wrapping of medium weight or light goods, or of fragile or deformable goods.	Various widths Non-adhesive as well as single- adhesive With advanced resistance to UV radiation
POWERFLEX HPQ	250%	Use similar to PQ.	Various widths Non-adhesive as well as single- adhesive With advanced resistance to UV radiation
POWERFLEX SPQ	300%	Use similar to PQ or HPQ.	Various widths Non-adhesive as well as single- adhesive With advanced resistance to UV radiation

For putting of the wrapping machine into operation, we recommend to contact the supplier or producer, who will recommend the optimal stretch film for wrapping of your goods from of his/her experience.

We do not recommend using of other wrapping material than it is mentioned hereinafter (e.g. perforated films, network, layered, printed, bubble, from other material, etc.) without previous producer consulting and without his consent – it is not possible to guarantee the correct function of the wrapping machine. If the machine wraps in low-quality in the duration of guarantee, or if the machine damage or damage of the wrapped goods occurs, the use of films or wrapped materials, which were not approved by the producer, may be the reason for complaint rejection.

2.6.1. Ecology

It is possible to include the stretch film into the sorted waste among plastics (more precisely among the polyethylene PE). Material is easy recyclable. It can be easily burnt and on the correct burning conditions, no pollutant emissions spring. It is not biodegradable and degradation in the dumping place is very slow. No dangerous products leaking in the air or contaminating water or ground, are known.

2.7. Operation

The machine is designed for work of one person. The workplace at the control panel secures that the staff is out of reach of the machine working area.

2.8. Electric Components of the Machine

The electric components of the machine are realized according to EN 60204-1. Each machine is checked before despatch and it is tested for fulfilment of requirements of standard EN 60204-1.

The machine is shielded and this shielding corresponds to group 1, class A. according to EN 55011.

In light of resistance to interference, the machine matches the requirements of these standards:

- IEC 1000-4-2, EN 61000-4-2
- IEC 1000-4-3, EN 61000-4-3
- IEC 1000-4-4, EN 61000-4-4
- IEC 1000-4-6, EN 61000-4-6

Electrical components of the machine contain the switchboard and electric mains on the machine. Five-pole input terminal block and switch for the whole machine are placed in the switchboard. Supply to the machine has to be protected by fuses or circuit breaker. The electrical power network, to which the machine will be connected, has to match international and national regulations and standards.

3. SAFETY INSTRUCTIONS

3.1. Revisions and Tests of the Electric Equipment

The machine is liable to regular revisions and tests of the electric equipment. During this work, it is necessary to satisfy the requirements of EN 60204-1.

Before putting of the machine into operation, the revision of electric equipment has to be carried out – see chapter 4.5

3.2. Safety Recommendations

Regarding the fact that each unprofessional intervention into the electric equipment might cause serious machine damage or staff injury, every intervention may be carried out only by the person competent according to the national regulations for work on electric equipment.

Workers operating the machine must be provably familiarized with these instructions for use and this manual must be permanently available for the staff.

The main machine switch on the switchboard is lockable and it enables locking of the switch in the switched-off position. We recommend to user solving of the manipulation with the key from the lock within the plant, where the machine is installed and thus preventing putting of the machine into operation by person who is not familiarized with the instructions.

3.3. Work Safety

3.3.1. Protective Devices for Ensuring of Work Safety

The wrapping machine is equipment of simple construction without presence of hazard places, which might cause health threat to the staff during working operation on condition of following the established working procedure of wrapping.

Hazard places in the working area arise from the principle of the machine operation:

- 1) The turntable rotates with the pallet, which is situated on it. The rotating part of the machine with the pallet is not protected with special covers, because this would disable the technological operation itself.
- 2) The film is stretched between the rolls of the prestretch device.
- 3) The film is reeled up on the wrapped goods and it is tightened on them by force.
- 4) An electrostatic charge may be created on the film.

- 5) The prestretch device travels along the whole height of the mast down to the ground.

For ensuring of the staff protection, the following is used:

- 1) Button **EMERGENCY STOP** for quick stop of the whole equipment. The button is mechanically blocked in the pressed position and it is placed within the reach of the staff on the control panel.
- 2) Button **CONTROL VOLTAGE**. During outage of power supply or during pressing of button Emergency stop, the power supply for control system will be disconnected and the machine will not carry out any activity, even when the power supply is restored or when the button **EMERGENCY STOP** is accidentally or by staff's or maintenance's mistake unblocked prematurely. Only pressing of button **CONTROL VOLTAGE** will allow the next machine operation.
- 3) The machine control is realized from the control panel, which is placed on the lateral side of the machine, so that it was out of reach of the machine working area.
- 4) Rotating parts of the transfer devices are constantly placed in the machine construction.

3.3.2. Obligations of Machine Staff and User

Staff is obliged to keep the following instructions for his/her safety:

- 1) In principle, the machine staff is one person. Nobody except staff may stay near the machine during the working cycle.
- 2) Staff must stay out of reach of the working area (i.e. by the control desk) during the whole duration of the machine operation.
- 3) Only worker above 18 years, who was determined to do so and who was provably familiarized with this manual and these safety rules, may operate the wrapping machine.
- 4) Before start of the work, the staff is obliged to check the overall condition of the machine and correct function of the individual machine parts, in particular the safety of electric cables. He/she must keep the workplace and its surroundings clean during the work.
- 5) The staff is obliged to operate and maintain the machine in accordance with this manual. The correct use of machine prevents material damages and injuries.
- 6) The staff must not be intoxicated by alcohol, addictive drugs or medicines, which may affect the work safety.
- 7) It is possible to replace the coil with the film or anyhow manipulate with the prestretch device, only when the machine is inactive.
- 8) The staff has to put the pallet on the turntable so that it does not overreach the turntable shape with any its part. The pallet must not be put on the turntable eccentrically.

- 9) It is allowed to pick, dismount or lift off the covers only after the full stop of the machine and after securing of the switch-off condition.
- 10) The rotating machine parts have to work in the direction of the arrow, which is placed on them.
- 11) Safety symbols, symbols and notices on the machine must be kept legible. The user is obliged to restore their conditions in accordance with the original version when they are damaged or illegible.



It is forbidden:

- 1) **To use the machine for other purposes or in other way than it is stated in these Instructions for use.**
- 2) **To put the machine into operation and use the machine when the protective devices (covers, films, keyboards) are dismounted or damaged.**
- 3) **To touch the moving machine parts, rotating pallets or reeling film.**
- 4) **To manipulate in the area of rolls of the prestretch device, when the turntable is moving.**
- 5) **To walk or anyhow manipulate in the area between the mast and the turntable.**
- 6) **To enter on the rotating turntable.**
- 7) **To operate the machine when the machine working area and the workplace are not lighted sufficiently.**
- 8) **To realize the maintenance, cleaning and repairs, when the machine is not stopped by the main switch and secured against the accidental start.**
- 9) **To realize the check-up or repairs of the electric equipment by the person, who does not have the necessary qualification.**
- 10) **To disable the safety, protective and securing equipment, or interfere with the construction or electric elements of the machine.**

3.4. Work Hygiene

Weight of the wrapping film roll is approximately 17 kg. Manipulation with weights over 15 kg is forbidden for all women and juveniles.

Working environment, where the machine is used, is affected by the character of produced and wrapped goods. The user is obliged to secure the work safety and

health protection of the workers in accordance with national regulations for health protection.

To reduce the physical effort during manipulation with wrapped pallets, the staff has to use the mechanization hoisting units, which were allocated to him/her by the employer for this purpose.

If the character of the wrapped product is such that injury of hand or of other body part of the staff may occur during the manipulation with the wrapped product or if the wrapped goods do not satisfy the hygienic limits (chemical and biological substances, dustiness, noise, etc.), the staff has to use the personal protective equipment, which the machine user allocated to him/her for this purpose.

The equivalent sound pressure level weighted by A function in the duration of the wrapping cycle is 63.9 dB in the place of staff; the machine itself satisfies the hygienic limits. Precautions for protection against noise are affected by the situation in the workplace and they adhere to the national regulations for health protection.

3.5. Fire Protection

For securing of the fire safety during use of the wrapping machine, the user has to equip the workplace of the wrapping machine by the appropriate fire-stopping materials. Their designation and placement must be discussed and approved with the professional workers of fire protection and inspection, especially in connection with the character of the processed materials and in connection with the fact that the wrapping machine is electric equipment.

The fire prevention officer of the user will determine the placement and selection of the fire extinguishers according to the local conditions.

3.5.1. Instructions for the Machine Staff

In case of the fire accident, at first the staff must disconnect the electrical power supply by unplugging of the plug from the socket, or by turning the main switch off.

For the consequent extinguishing of the arisen fire, the staff has to use only the fire extinguishers, which were determined for that.

For extinguishing it is not allowed to use water extinguisher or foam extinguisher!

4. PUTTING INTO OPERATION

This chapter deals with stocking, installation and putting of **WS** machine into operation, it also contains information about potential later manipulation with used wrapping machine.

4.1. Stocking

Unless the machine is put into the operation immediately after delivery, it is necessary to stock it in the original protective wrapping in the covered place protected against atmospheric effects (rain, snow). The range of the stocking temperatures from 0°C up to +55°C, humidity from 5% up to 95% without condensation (dew). No corrosive substances or substances, which leak the exhalations damaging the insulation of the electric conductors, or substances which may create flammable or explosive environment, may be stocked in the place, where the machine is placed.

4.2. Project

Standard **WS** machines without the necessity of any building intervention does not demand any project preparation. If the supposed workplace matches the requirements for machine working environment according to chapter 2.2, it is possible to install the machine according to chapter 4.4 and put it into operation.

We recommend processing of at least simple project for the machines inserted in the embedded frame in the floor. The reason for that is later difficult replacement of the machine and of the cast-in frame. This project should solve the placement of the wrapping machine with regard to:

- Safety of the staff and other people staying near the workplace;
- Access to the wrapping machine with the manipulation technology for putting of the goods on the turntable and for removal of the wrapped goods outside of the machine.

4.3. Minimal Area around the Machine

For the staff safety it is necessary to keep the minimal area around the machine. It is forbidden to place any subjects in this area, any other machine or any other machine's working area are not allowed to overreach into this area.

Scheme of the minimal area does not suppose the area for putting the goods in and out.

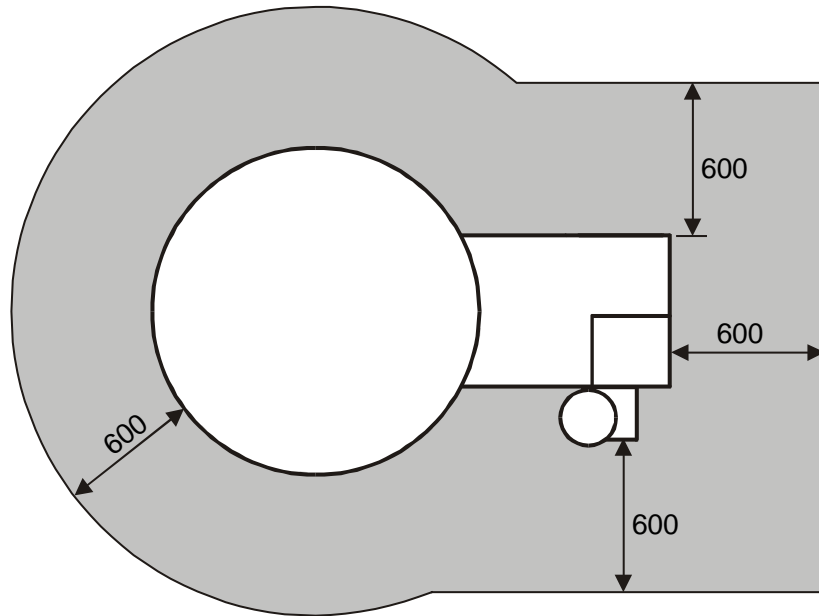

4.4. Assembly, Manipulation

Manipulation with the machine is possible by the help of high-lift truck; necessary dimensions of the skids and loading limit of the truck is always mentioned in the relevant article. For all machines it is forbidden to transport them by the help of hand pallet truck and by the help of the crane. Also it is forbidden to remove the machine with pallet loaded on it.

If the machine is exposed to quick temperature change during transport, it is necessary to wait an adequate time for equalization of the temperatures of the machine and surroundings before connection into the network – risk of humidity condensation (dew).

The machines are delivered with tipped mast, and it is necessary to erect it during putting into operation.

	!! CAUTION !!
	ALWAYS follow the work procedure and instructions stated hereinafter in the text, during erecting or tipping of the mast or during manipulation with the machine.
	NEVER try to manipulate with the mast without use of the tipping preparation! If the mast is erected and if it is not screwed to the turntable, it is unstable. Regarding the weight of the mast, there is a risk of serious injury and machine damage!
	The machine may never be lifted at the turntable during any manipulation!

4.4.1. Model with Standard Turntable

This is related to the standard machine model without forklift shaped cutout

The machine is delivered with the tipped mast. For manipulation with the machine there are ports for the skids of the high-lift truck in the carrying section, with dimensions of max. 130x50 mm, satisfying ISO 2328 – these ports are marked with the arrows in the picture. The loading limit of high-lift truck must be min. 1500 kg.

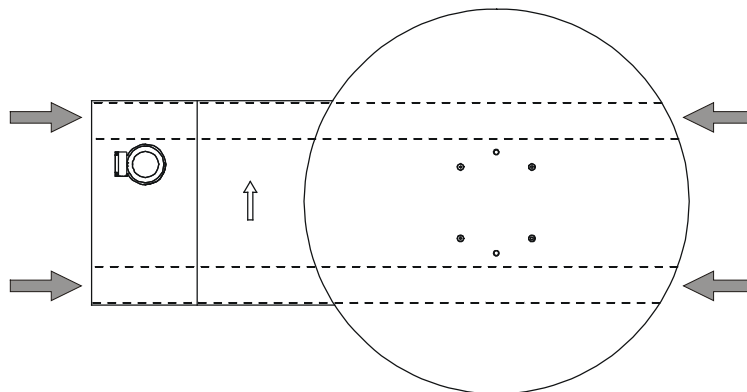

Put the machine in the place, where it will be used and put it into operation there. We do not recommend manipulation with operated machine – see below in this chapter. The machine workplace must satisfy the conditions stated in chapter 2.2.

Follow these instructions during **putting into operation**:

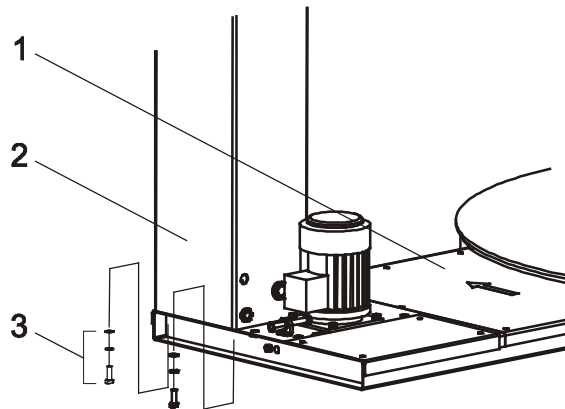

- Remove the protective wrappings and the film, which fixes the prestretch device to the mast.
- The mast is tipped in the manipulation preparation; this preparation is created by the hinge joint, around which the mast turns over when erecting.
- Connection accessories pos. 3 (2 pc screws M10×30, washers 10.5 and lock washers 10) are mounted on the relevant part of the machine from production. Screw them out and erect the mast pos. 2 (take care so that the cabling or optical sensor of the height of goods are not damaged; the mast weight is max. 120 kg according to equipment) and screw it down to the turntable pos. 1 with the connection accessories pos. 3 – screw it in the mast from below. It is necessary to keep the manipulation preparation installed.
- Remove the wooden support joist, which was inserted between the prestretch device and turntable.
- Remove the film, which fixes the prestretch device to the mast
- Check and eventually repair the orientation of the sensor of height of goods on pallet. This sensor is placed on the prestretch device, for procedure of check-up and adjusting see chapter 7.1.8.
- Finally, check the power supply and connect the machine to the network in the way according to chapter 4.5.

	<p>Keep all parts and connection accessories dismantled during putting machine into operation, for the case of later transport.</p>
	<p>For short distances (c. meters, only corrections of placement in the workplace) the machine may be carefully shifted in the erected position on the braced surface without unevenness and super elevation; as for the high-lift truck, the provisions from the introduction of this chapter are valid. By default, it is necessary to transport the machine in the tipped position, in which it was delivered.</p>

Act as follows during **preparing for transport** (positions and marking refer to the pictures in the part putting into operation:

- If the coil with film is filled in the prestretch device, remove it before preparing for transport.
- Move the prestretch device in the bottom end position (unless it is there). Turn the machine off and disconnect it from the network by unplugging of the plug from the socket.
- Fix the prestretch device to the mast with the stretch film, which is used for wrapping and reel it around the prestretch device and the mast with c. 5 up to 10 layers. The film must be tensioned during wrapping!
- Put the support joist on the turntable, so that the mast lays on it after tipping.
- Loosen the mast from the turntable - screw out in the places pos. 3 - 2 pc screws M10x30, washers 10.5 and lock washers 10. Keep the connection accessories for the follow-up assembly.
- Tip the mast. Take care so that the optical sensor of the height of goods on pallet is not damaged!

After shifting, the assembly is the same as the procedure of putting the new machine into operation in the introduction of this chapter, including the check-up of power supply according to chapter 4.5, especially in case of connection of the machine in other socket than before.

4.4.2. Model with Forklift-Shaped Turntable

It is related to the model of forklift-shaped turntable with diameter of 1500 mm.

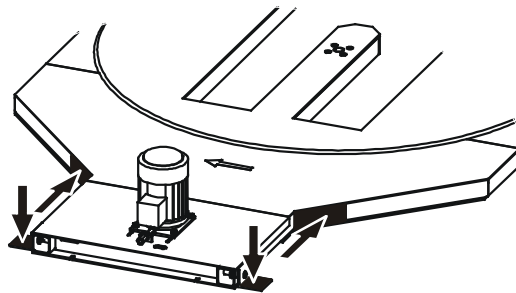

The following serves for **manipulation with the machine**:

- ports for the skids of the high-lift truck in the carrying section under the turntable, their depths are 170 mm (the shortest side of the section). Skids of the high-lift truck insert in these ports during transport.
- footings fixed on the turntable. They lean on the skids of the high-lift truck from below during manipulation.

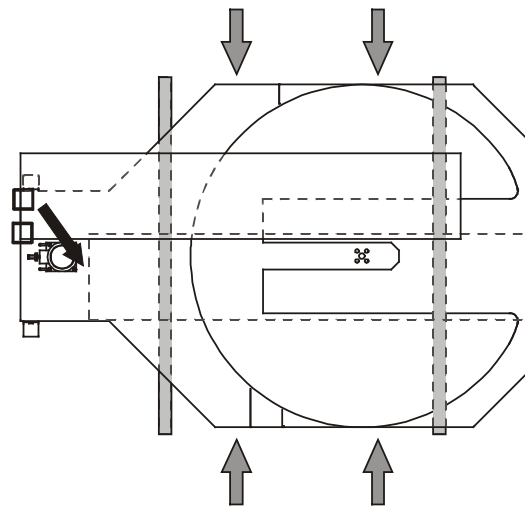

- The skids must have dimensions of max. 100×50 mm and length of min. 1000 mm and must satisfy ISO 2328. Spacing of the internal edges of skids is 720 mm. Loading limit of the high-lift truck must be min. 1500 kg.
- If requested, it is possible to deliver machine, which is underlaid by transport joists for easier manipulation by the high-lift truck. The truck skids insert in sideways – see light arrows in the picture – and they must have length of min. 1500 mm. Recommended loading limit of the truck is min. 1000 kg.

Putting into operation:

- Put the machine in the place, where it will be used and put it into operation there, the workplace must satisfy the conditions stated in chapters 2.2 a 4.3. We do not recommend manipulation with operated machine – see below in this chapter. The material mentioned below in the text, which is necessary for putting the machine into operation, is installed in the places, where it will be used later.

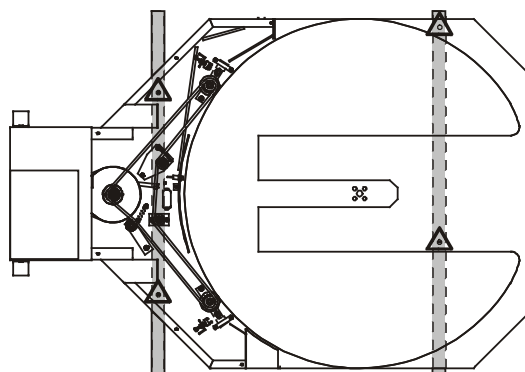

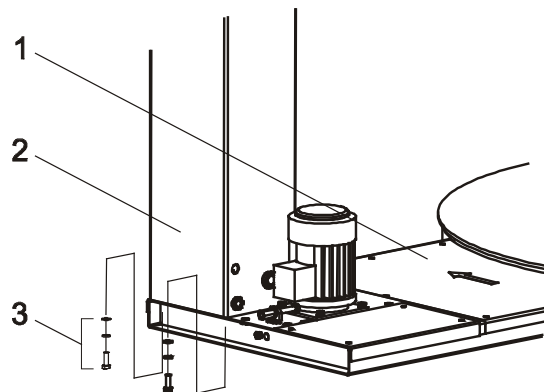

- Remove the protective wrappings
- If the machine is delivered on the transport joists: screw out and take off the cover between the turntable and the mast. Take out the screws fixing the transport joists – in the picture marked with Δ. Lift the machine using manipulation ports and footings and remove the transport joists. Put the machine on the ground again. Do not move the machine in any case!



- The mast is tipped in the manipulation preparation; this preparation is created by the hinge joint, around which the mast turns over when erecting.
- Connection accessories pos. 3 (2 pc screws M10×30, washers 10.5 and lock washers 10) are mounted on the relevant part of the machine from production. Screw them out and erect the mast pos. 2 (take care so that the cabling or optical sensor of the height of goods are not damaged; the mast weight is max. 120 kg according to equipment) and screw it down to the turntable pos. 1 with the connection accessories pos. 3 – screw it in the mast from below. It is necessary to keep the manipulation preparation installed.
- Remove the wooden support joist, which was inserted between the prestretch device and turntable.
- Remove the film, which fixes the prestretch device to the mast.
- Check and eventually repair the orientation of the sensor of height of goods on pallet. This sensor is placed on the prestretch device, for procedure of check-up and adjusting see chapter 7.1.8.
- Finally, check the power supply and connect the machine to the network in the way according to chapter 4.5.
- Remove the manipulation footings fixed on the turntable (by removal of the cotters in the internal side of the section and release of the footing from the port).

	<p>After setting of the machine in the place, it is necessary to remove the manipulation footings – when the footings are kept there; there is a risk of trip and injury.</p>
	<p>Keep all parts and connection accessories dismantled during putting machine into operation, for the case of later transport.</p>

	<p>For short distances (c. meters, only corrections of placement in the workplace) the machine may be carefully shifted in the erected position on the braced surface without unevenness and super elevation, if it is placed on two pallets and the skids of the high-lift truck load it in the sideways. As for the high-lift truck, the provisions from introduction of this chapter are valid. Use the footings and manipulation ports for lift of the machine so that it would be possible to lay the pallets under the machine. By default, it is necessary to transport the machine in the tipped position, in which it was delivered.</p>
	<p>It is forbidden to transport the machine in the erected state using footing and manipulation ports in the turntable!</p>

Act as follows during **preparing for transport** (positions and marking refer to the pictures in the part putting into operation):

- If the coil with film is filled in the prestretch device, remove it before preparing for transport.
- Move the prestretch device in the bottom end position (unless it is there). Turn the machine off and disconnect it from the network by unplugging of the plug from the socket.
- Fix the prestretch device to the mast with the stretch film, which is used for wrapping and reel it around the prestretch device and the mast with c. 5 up to 10 layers. The film must be tensioned during wrapping!
- Put the support joist on the turntable, so that the mast lays on it after tipping.
- Loosen the mast from the turntable - screw out in the places pos. 3 - 2 pc screws M10x30, washers 10.5 and lock washers 10. Keep the connection accessories for the follow-up assembly.
- Tip the mast. Take care so that the optical sensor of the height of goods on pallet is not damaged!

After shifting, the assembly is the same as the procedure of putting the new machine into operation in the introduction of this chapter, including the check-up of power supply according to chapter 4.5, especially in case of connection of the machine in other socket than before.

4.5. Connection of the Machine to Network

At first, check the operational voltage and frequency of the machine stated in the plate of the electric equipment, if they correspond to voltage and frequency of the electrical network, to which it should be connected. Distribution of the electrical network and connection of the sockets have to correspond to the valid standards. Voltage fluctuation of max. $\pm 5\%$ of the nominal value still secures the correct machine function.

The connection of the machine is realized via cable ended with plug CVG 1643, which is connected to the terminals U,V,W,N,Pe in the switchboard. The supply cable must be led so that the manipulation or transport technology does not drive over it and so that it is not a source of injuries.

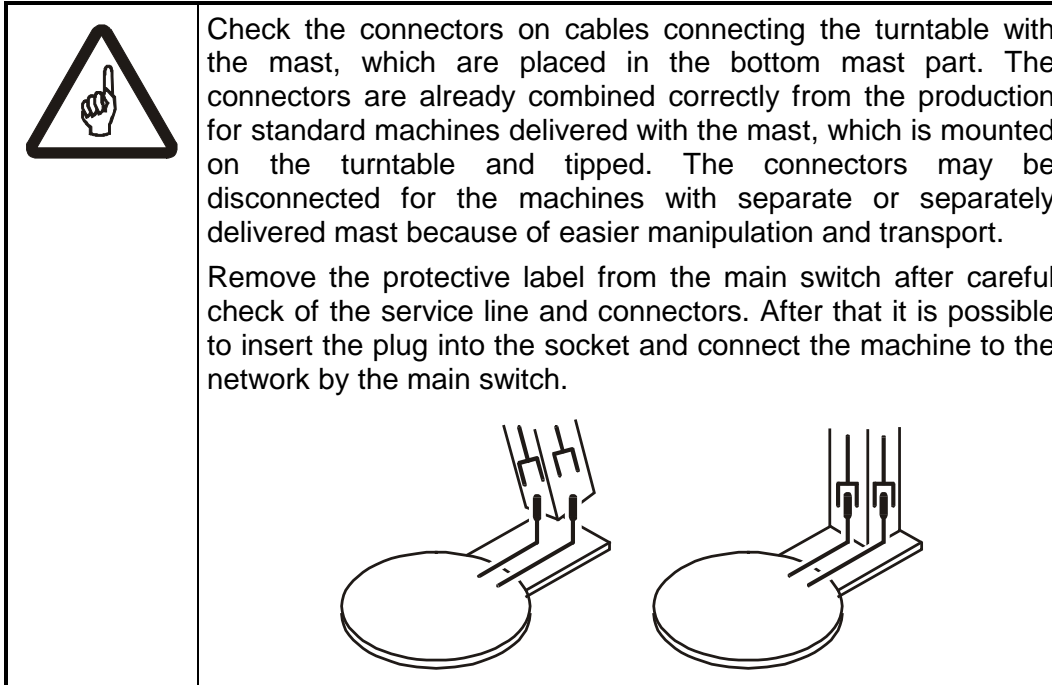

Check the phase-matching of the machine. Carry out this check-up always when the machine is connected to other socket than before. The machine turntable or prestretch device must move in the correct direction according to the arrows on the control panel. **Caution** - check the drive, where the frequency convertor of revolutions is not included. **You must disconnect the electrical power supply** to the machine by switching-off the main switch and unplugging of the plug from the socket, when re-phasing the machine. Only person competent in the terms of chapter 3.2 may carry out the re-phasing of the machine.

External protective terminals on the machine and contactor switchboard must be connected by the user to the user's protective system and they have to be conserved properly.

Before putting of the machine into operation the correct function of protection against hazardous contact voltage has to be tested according to IEC 60364-4-41 and revision of the power supply equipment (cable connection) of the machine must be realized according to IEC 60364-6 by the worker for revisions realization, who satisfies the conditions of national regulations for revisions.

4.6. Machine Dismounting

Before disposal of the machine after end of its technical service time, move all mechanisms in such positions so that there is no risk of fall of the loosened machine parts from the height and so that it is possible to safely remove the parts. Disconnect the electrical power supply by unplugging of the plug from the socket. Person qualified according to chapter 3.2 will check the electrical circuit

because of the presence of remanent voltage before start of dismounting; if there is some, it is necessary to discharge this voltage or to wait until the circuit discharges spontaneously.

Dismount the motors with gear-boxes, remove oil from them and put it into firm, unbreakable and impermeable container the.

Dismount all machine elements.

Sort all the elements according to waste classes (steel, non-ferrous metals, plastics, cables, electric elements, etc.). Such assorted waste including the lubricants hand over to the specialized companies for professional disposal.

5. EQUIPMENT

5.1. Description, Accessories

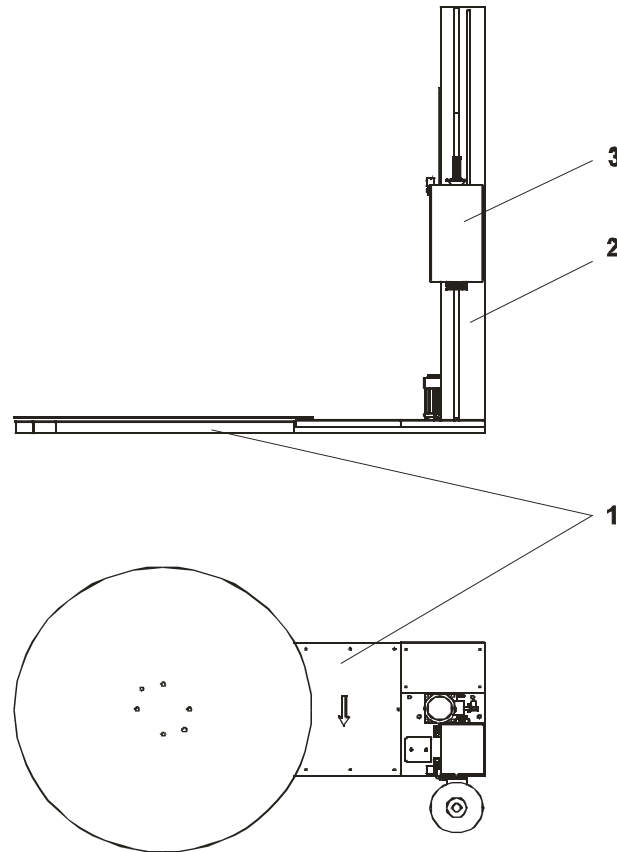

- 1 **Base frame with round turntable** (chapter 5.2)
- 2 **Mast** (chapter 5.3). **Control panel** is part of the mast (chapter 5.5).
- 3 **Prestretch device** (chapter 5.4) travels on the mast and secures stretching of the film and its wrapping on the goods on pallet.

5.2. Turntable

Machines **WS ECONOMIC** can be equipped with the turntable:

- **Standard.** Manipulation with the pallets is by the help of high-lift trucks, it is possible to use even low-lift trucks after adding of drive-up ramp. If requested, it is possible to deliver the turntable with planette for locking of the film before start of the wrapping; it is possible to mount it on even additionally. Standard diameter of the turntable is 1500 mm and it is designed for wrapping of standardized europallets 800×1200 mm. Turntable with diameter of 1650 or 1800 mm serves for wrapping of bigger pallets.

WS PRACTIC machine is equipped with the following turntable:

- **Forklift-shaped**, which makes the loading of pallets to the wrapping machine easier by the help of low-lift manipulation trucks without the necessity of using the drive-up ramp. Standard diameter of the turntable is 1500 mm and it is designed for wrapping of standardized europallets 800×1200 mm. Turntable with diameter of 1650 or 1800 mm serves for wrapping of bigger pallets. Other operation of the machine, its control and possibility of using the plangette for locking of the film are standard.

Both turntable models are driven by electric motor with inter-gear. First stage of the inter-gear is solved by the V-belt; the second stage is a chain gear. The consequence of V-belt use is more quiet operation, quite soft start and after-running, and possibility of turning the turntable by hand against the gear resistance – however, this possibility should be used only rarely.

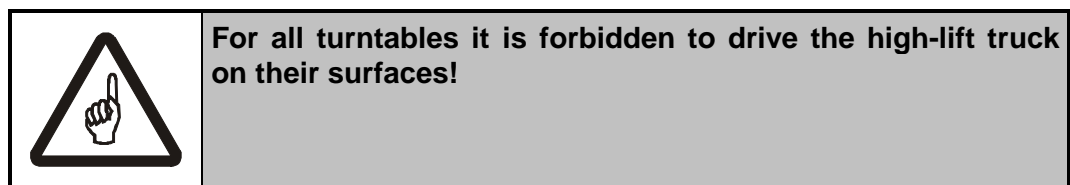

5.2.1. Drive-Up Ramp

It is not a standard part of the machine, it is delivered to order. If carrying of the goods on the standard turntable (not forklift-shaped) with low-lift truck or other hand manipulation technology is requested, it is possible to add the drive-up ramp to the machine. This ramp will be firmly mounted to the basement during the assembly at the customer's; its placement (orientation) is given by the area and manipulation conditions in the workplace. It is possible to install the ramp during the machine delivery or anymore later.

5.2.2. Flush Frame

It is not a standard part of the machine, it is delivered to order. Likewise for the drive-up ramp, if carrying of the goods on the standard turntable (not forklift-shaped) with low-lift truck or other hand manipulation technology is requested, it is possible to use the flush frame. The frame use demands building modifications of the workplace (ground recess and frame concrete encasement), and then the wrapping machine is inserted into the flush frame without any assembly or other work. The turntable surface then gets in the floor level and it is not necessary to surpass the difference in elevation when bringing the goods. It is possible to install the flush frame during the machine delivery or anymore later.

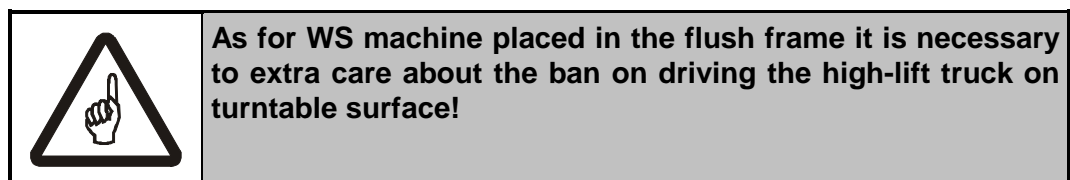

5.3. Mast

The machine mast is fixed to the mounting base with screws. Its construction is created from box sections. The electric switchboard and control panel are

integrated into the mast. The internal mast area contains lead and travel skids and electric drive for travel of the prestretch device, switchboard and set of end sensors. The basic mast length is 2150 mm

5.4. Prestretch Device

The truck, which secures the vertical movement of the prestretch device along the mast, is hidden inside the mast and it travels along the whole height of the mast. It is created by welded frame with travel rollers, driven by electric drive via textile belt. The prestretch device itself is mounted on this truck.

In machines of **WS** types is - as per order – used one of the prestretch device types, described in chapters 5.4.1 to 5.4.3, which serve for reduction of wrapping material (stretch film).

The films, which are designed for prestretch devices, are specified in chapter 2.6.

The primary stretching occurs between the rolls of the prestretch device because of the difference in speed of their rotation, the main effect is the film reduction. The secondary stretch occurs between the prestretch device and pallet because of the pallet movement against the braked rolls of the prestretch device and it defines the tightness of the wrapping (tightening of the film around the wrapped goods).

The device activity is controlled from the control panel of the wrapping machine.

	<p style="text-align: center;">The machine turntable MUST NOT be moving during any work in the area of rolls of the prestretch device!</p>
---	---

5.4.1. Manual Film Brake

Simple economical solution for occasional wrapping without demands on wrapping quality and film reduction. Tension of the film during wrapping is reached manually by turning the handle, which tightens or loosens the brake. The brake setting is ensured by the securing wobbler. Primary stretching is not possible there, only secondary stretching may be applied, the value of which is experimentally set manually by the handle. This device is designed for undemanding wrapping without high demands on wrapping quality and reduction of wrapping material and it is designed for occasional wrapping (c. ones of pallets a day).

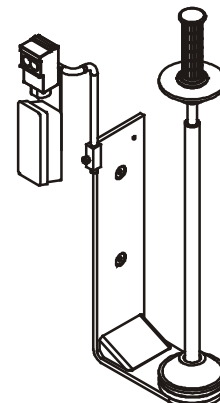

The prestretch device is created by framework and film holder.

Filling of the film: loosen the wobbler and screw out and take out the handle (including the wobbler and cone). Put the new film on the spine and screw the handle back. Loosen the wobbler above the handle when adjusting the brake force. Tighten or loosen the brake by turning the handle and thus set the brake

force. After adjusting of the film tension tighten the wobbler again and thus you will secure the set film tension.

5.4.2. Mechanic Prestretch Device

Economic for demand on lower film consumption by its stretching between the rolls of the prestretch device. The film is unrolled from the coil by the movement of the turning pallet. The primary stretching of the film and thus the film reduction occurs between two main rolls, which are engaged together via chain gear. It is possible to set the gear ration by replacement of the chain-wheel on the roll and chain; it is possible to deliver sets of cog-wheels for various stretch sizes (80%, 130%, 180%) according to the kind of the stretch film. The secondary prestretch results from pallet movement against the main roll, it is given by the structure of the prestretch device, so it is not possible to regulate it. Mechanic prestretch device is an economical solution for middle wrapping capacity without the demand on regulation of the film stretching.

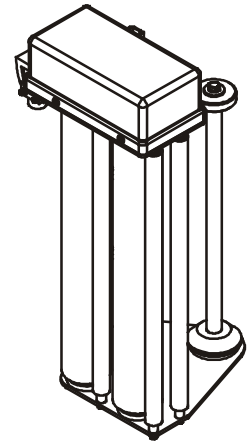

The prestretch device is created by framework, film roll holder, set of main rolls and auxiliary guide rolls.

Unless it was stated otherwise in the order, the primary film stretching is set 130% from production, which satisfies the common used films and wrapping procedures. If you need to change the primary stretching, there is a set of chain-wheel and chain of cog-wheels for various stretching sizes (80%, 180%). Only the gear chain-wheel and chain are changed, the pinion is kept the same for all values of the primary stretching. Take off the upper cover of the prestretch device, screw out the screws in the shaft axis of the chain-wheels and pull both wheels and the chain off. Install the new chain and new chain-wheel with the original pinion in the reverse procedure (pinion always belongs to the main roll closer to the mast).

Stretching	Number of gear teeth	Chain
80%	22 t	Length 400
130%	27 t	Length 419 + half link
180%	34 t.	Length 457 + half link

The correct chain tension and adjusting procedure during change of primary stretching, during its replacement or during maintenance of the prestretch device are described in chapter 7.1.6.

You fill the new film so that you put the new film roll on the spine and lead the end of the film between the rolls according to the scheme glued on the drive cover. Act analogically during the repeated filling of broken film.

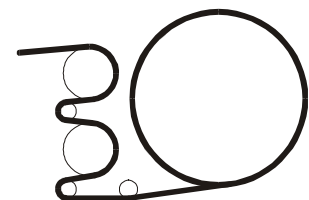

5.4.3. Electromagnetic Film Brake

Prestretch device for lower and middle wrapping capacities. The film is lead across one working roll. Primary stretch is not possible there, only secondary stretch may be applied there, which is defined by the pallet movement against the working roll, which is braked by the electromagnetic brake. The stretching force is regulated by the control system; stretching force is given by the force of electromagnetic brake. Use of electromagnetic brake enables manipulation during fastening the film to the pallet and enables use of bigger secondary stretch (i.e. bigger tightening of the film around the goods on the pallet).

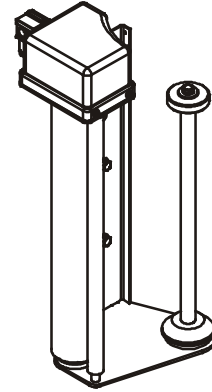

The prestretch device is created by framework, film holder and main roll, which is affected by the electromagnetic brake.

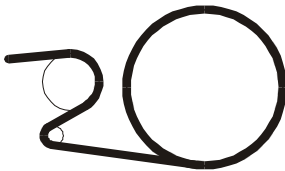

Fill the film in this way: put the roll on the spine and lead the film around the roll according to the scheme glued on the prestretch device.

As for this type, the occasional check-up of the brake is necessary, especially of its lining. For closer instructions see chapter 7.1.7.

5.4.4. Measuring of the Height of Goods on Pallet

All **WS** wrapping machines are equipped with the system for measuring of the height of the goods on the pallet. This equipment serves for prestretch device to automatically stop after wrapping of the pallet top.

An optical sensor is placed on the prestretch device and this optical sensor takes the immediate height of the pallet during the travel of the prestretch device. From the moment when the optical sensor does not record any reflection (it is above the height of the goods on pallet), the prestretch device continues in travel up to the track, which is set in the machine parameters and then it stops.

The sensor must be adjusted correctly – procedure during check-up and adjusting is mentioned in chapter 7.1.8.

5.4.5. Directed Stop

Directed stop means that the turntable will always stop in the same position, which makes the work organization easier during putting the pallets on and off.

The accuracy of the directed stop is also affected by the inertia of the rotating pallet. Therefore it is necessary to act according to the following procedure: Place the first pallet of certain weight on the machine turntable and start the wrapping cycle without filling the film. After the end of the cycle, the pallet will stop in the direction, in which all the following pallets of the same or of weight,

which does not differ for more than 100 kg will stop. Mark the position of the turntable in reference to the machine frame. Remove the pallet from the turntable and eventually put the drive-up clapper-bridge to the machine in the direction, which will be suitable for carrying the pallets on.

If the forklift turntable stops so that it is not possible to carry the pallet away easily (the forklift-shaped cutout is not stopped directed), turn the pallet manually against the gear resistance.

5.5. Control Panel

The system is equipped with foil keyboard. It is necessary to avoid all activities which may lead to damage of buttons or to damage of the covering film (e.g. press the buttons with sharp objects or affecting the buttons with extreme force, strokes, etc.).

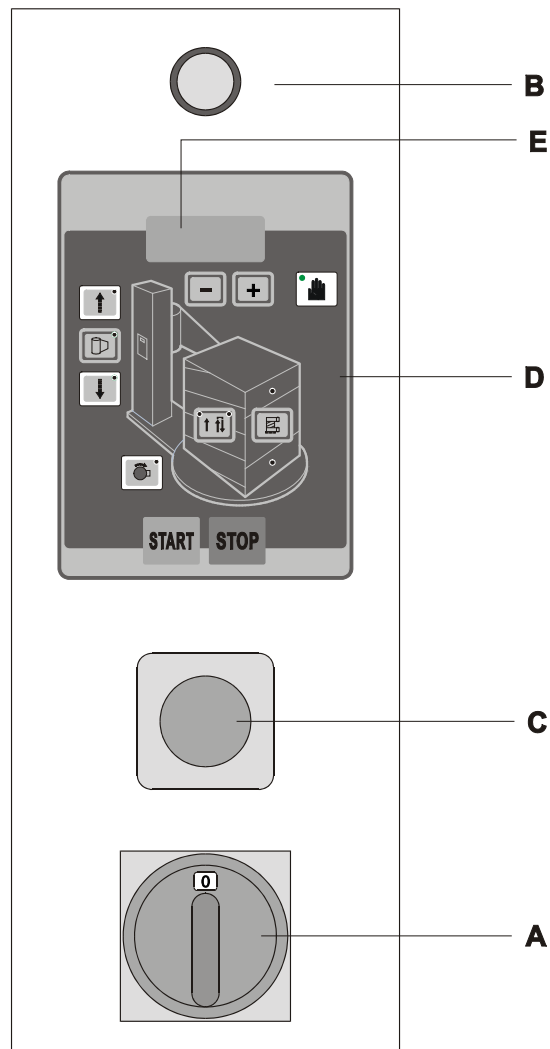

When this film is damaged, secure its repair without delay (see chapter 7.1.10).

All system buttons are described in this chapter.

A) Main switch

It is placed on the mast. It is lockable and thus it allows an unauthorized person to prevent the manipulation with the machine.

B) Button Control voltage



The buttons starts the power supply for control system after the machine switch-on or in case that the disconnection of the power supply for the control system occurs as a result of failure. Normal status is indicated by lighting button, if it is off, the control voltage is disconnected. Press of this button restores the power supply for the control system.







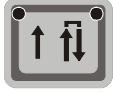

C) Button Emergency stop

After press of this button, all machine movements immediately stop, power supply for the control system will be disconnected (button **CONTROL VOLTAGE** will get dark) and the error message **tStP** will be displayed. It serves for machine stop in emergency or breakdown situation – fall of the goods from the pallet, machine collision with the goods, machine damage, staff injury, etc. During repeated putting of the machine into operation after press of button **EMERGENCY STOP** the instructions in chapter 5.6.1 are valid.

D) Buttons controlling the machine operation

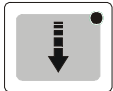
Buttons with yellow edge are working in manual as well as in automatic mode.

	Automatic mode	Manual mode
	Start of wrapping cycle	turntable rotation
	Interruption of the wrapping cycle. StOP is glimmering on the display, after pressing button START wrapping continues from the point, where it was interrupted. After repeated press of the button STOP , wrapping is finished.	stop of the turntable rotation
	Changeover to the manual mode. The indicator lamp on the button is off in the automatic mode.	Changeover to the automatic mode. The indicator lamp on the button is lighted in the manual mode.

	Automatic mode	Manual mode
	Changeover of simple / cross wrapping (see chapter 6.3, 6.6)	Without function
	By default: change of the selected program Parameter editing: Increasing the parameter value	Increasing the parameter value
	By default: change of the selected parameter Parameter editing: Decreasing the parameter value	Decreasing the parameter value
	Speed of the prestretch device travel upwards	prestretch device travel upwards. After pressing the button, the prestretch device travels upwards, until it is moving below the height of goods on pallet and farther for approximately 10 to 15 cm. If the prestretch device moves upwards, the repeated press of this button stops the travel. If it is necessary to move the prestretch device higher, you have to hold the button pressed for whole period of the movement.
	Speed of the prestretch device travel downwards	prestretch device travel downwards. After pressing the button, the prestretch device travels downwards to the bottom end position. If the prestretch device moves downwards, the repeated press of this button stops the travel.
	Settings for number of revolutions up/down (the indicator lamp signalizes which parameter can be set)	Without function
	Secondary stretching (only in machines, which are equipped with electromagnetic prestretch device)	Secondary stretching (only in machines, which are equipped with electromagnetic prestretch device)
	Speed of turntable rotation. the parameter is working only when the turntable rotation is regulated by the frequency convertor.	Speed of turntable rotation. the parameter is working only when the turntable rotation is regulated by the frequency convertor.

E) Display

The display serves for communication of the machine with the staff. It shows up to four digits (letters, numbers). All machine messages are mentioned in the table:

Display	Meaning
A- <i>program number</i>	Machine is in automatic mode, number indicates the selected program. If the machine is inactive, message is lighting, if the machine executes the program (it is moving), text is glimmering.
H	Machine is in manual mode.
tStP	CONTROL VOLTAGE is not on after start of the machine or after unblocking of the button EMERGENCY STOP . The button EMERGENCY STOP is pressed.
StOP	The button STOP is pressed. In simple wrapping (see chapter 6.3 and the following). Machine finished wrapping and the prestretch device is out of the bottom position.
<i>numbers</i>	Parameter values during their setting. Values are kept on the display for c. 30 s after end of their setting.
ErrV TIMV <i>E-number</i>	Error messages. For their meanings and treatment see chapter 6.8

5.6. Safety Equipment

The machine is equipped with several safety elements for health protection of the worker, who is operating the machine, or for minimalization of damages resulting from emergency events.

5.6.1. Button Emergency Stop

Button **EMERGENCY STOP** is placed near the control panel and it serves for immediate stop of the machine in case of emergency (machine defect, fall of the goods from the pallet, collision, injury). After press the button is immediately arrested in the pressed position, before the follow-up start of the machine it is necessary to unblock the button.

Act as follows during the follow-up putting of the machine into operation:

- Remove the cause of the emergency stop
- Check the condition of the machine
- Unblock the button **EMERGENCY STOP** by turning to the right (it is indicated by the direction of the arrow on the button), until it is turned back in the initial position
- The display still shows **tStP**. Restore the power supply for control system of the machine by press of the button **CONTROL VOLTAGE** and at the same time

the display signals **A** or **H** – according to the mode at the moment of pressing button **EMERGENCY STOP**, unless the machine was turned off meanwhile.

5.6.2. Button Control Voltage

This button and its function matches the requirements of standards and regulations as a preventer against an unexpected and undemanded machine operation after the machine start, failure, power failure or presence of signal of Emergency stop. During power failure or during press of the button **EMERGENCY STOP**, the system control voltage will be disconnected and the machine will not perform any activity, even when the power supply is restored or when the button **EMERGENCY STOP** is unblocked by the staff's mistake or by any other unprofessional or accidental action. Only press of the button **CONTROL VOLTAGE** will allow the next machine operation. It is also necessary to press this button when starting the machine. Power supply for control system is indicated by lighting of this button, when the power supply is disconnected the button gets dark.

6. WRAPPING

6.1. Machine Switch-On and Switch-Off

The machine is switched on by changing over the main switch on side of the switchboard to position "I" and by press of the button **CONTROL VOLTAGE**. Indicator lamp of **CONTROL VOLTAGE** must be lighted; if it keeps dark, the button **EMERGENCY STOP** was pressed – then act according to chapter 5.6.1. Various characters and symbols can appear, until the button **CONTROL VOLTAGE** is pressed, the display signals **tStP**. After few seconds these message disappear and the machine will be always in the automatic mode – **A-** and program number will show on the display. After start the program, which was active at the moment of the previous machine switch-off, will be selected. The indicator lamp on the switch of automatic and manual modes will be off.

The machine is switched off by changing over the main switch to position "0".

6.2. Film Replacement and Filling

Films, for which the prestretch devices are designed, are specified in chapter 2.6.

Procedure for replacement of the film differs according to the used prestretch device – for complete procedures of film replacement see chapter 5.4.

6.3. Types of Wrapping

On **WS** machine you may wrap the goods on pallet in several types of wrapping, which represent various degrees of fixation of the goods on pallet and of their protection.

In **automatic mode** (chapter 6.4) it is possible to wrap the goods in the following ways:

- A) Simple wrapping.** It is wrapped in one direction, bottom-up. This type is the most economic regarding the film consumption.
- B) Cross wrapping.** The prestretch device travels bottom-up, the upper film edge travels approximately 10 up to 15 cm above the pallet; it wraps the pallet top in several rotations and then the prestretch device travels back to bottom. The pallet is more protected and fixed with double layer of the film. This wrapping is automatically selected after the machine start.

In **manual mode** (chapter 6.5) it is, besides the described simple or cross wrapping, possible to wrap with overlay (i.e. during wrapping the overlapping film is laid manually on the top of goods on the pallet, this overlapping film protects the wrapped goods against dust and weather influences). The exact wrapping procedure is stated in chapter 6.5:

- C) Simple wrapping with overlay.** After simple wrapping of the pallet, the prestretch device travels down for approximately 30 cm, the turntable stops and after manual lying of the overlapping film the turntable again operates and the prestretch device travels above the pallet, where it fixes the overlapping film to the pallet in several rotations. The pallet top is protected against dust, humidity and adverse atmospheric influences.
- D) Cross wrapping with overlay.** After second wrapping of the pallet top because of fixation of the overlapping film, the prestretch device travels back to bottom. This type combines good fixation and protection of goods with double layer of the film as well as protection of the pallet top against dust, humidity and adverse atmospheric influences.

6.4. Wrapping in Automatic Mode





WS wrapping machines allow wrapping in automatic mode. This mode is always selected as initial after the machine start, the indicator lamp on button **SWITCHING OF AUTOMATIC AND MANUAL MODE** is off and **A-** program number is lighted on the display. **WS** wrapping machine have two programs, which may be changed over by press of button **+** or **-**.

If the machine id in manual mode (the indicator lamp on the button is lighting and **H** is shown on the display), you will switch the machine back to the automatic mode by pressing the button **SWITCHING OF AUTOMATIC AND MANUAL MODE**

It is possible to interrupt the program operation whenever by pressing the button **STOP**, **StOP** is shown on the display. After pressing the button **START** the program continues in wrapping, after pressing the button **STOP** wrapping is finished.

The wrapping procedure slightly differs according to selection of cross or simple wrapping.

Simple wrapping	Cross wrapping
Place the wrapped pallet on the turntable.	
	The pallet must be placed symmetrically to the turntable centre and it must not overreach the turntable perimeter.
Unroll the sufficient long piece of the film from the film coil and fasten its end to the wrapped pallet (e.g. by lashing to the chock of the wrapped pallet).	
	During filling the film take care so that the film cannot get under the rotating part of the turntable anymore later during the wrapping; there is a risk of reeling of the film on the turntable chain and central bearing and eventually fall of the chain from the cog-wheel and from pinion.
If necessary, select the demanded program by pressing the button + or - .	

Simple wrapping	Cross wrapping
Press the button START . The machine will wrap the pallet with the goods; during wrapping symbol A –program number is glimmering on the display. Finally the turntable stops at the position of directed stop (chapter 5.4.5).	
After total stop of the machine, cut the film and burnish its end to the wrapped pallet.	After total stop of the machine, the prestretch device will stay in the upper position and StOP is glimmering on the display. Cut the film and burnish its end to the wrapped pallet.
	Press the button START , the prestretch device will move to the bottom position and after its stop A –program number shows on the display.
Remove the wrapped pallet. The machine is in initial position again and it is ready for next work.	









6.5. Wrapping in Manual Mode





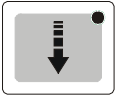

It is necessary to select the manual mode by pressing the button **SWITCHING OF AUTOMATIC AND MANUAL MODE**, indicator lamp on the button turns on and **H** is signalled on the display.

For complete description of functions of individual buttons in manual mode see chapter 5.5. If the black box is in the column Wrapping type, it means that the action is not performed in the given wrapping type, for overview of wrapping types see chapter 6.3. For example line 13, action "Lay the overlapping film after total stop ", is performed only in C wrapping types – simple wrapping with overlay and D – cross wrapping with overlay.

	Wrapping type					
	A	B	C	D		
1					Turn the machine on – see chapter 6.1	
2					Switch the machine into the manual mode	
3					Move the machine into the initial position, unless it is there: <ul style="list-style-type: none"> • prestretch device is in the bottom position (press the button for prestretch device travel downwards and wait until the prestretch device stops in the bottom position) 	
4					Place the wrapped pallet on the turntable. The pallet must be placed symmetrically to the turntable centre and it must not overreach the turntable perimeter.	
					WS with standard turntable: Use high-lift truck.	
					WS with drive-up ramp, With forklift-shaped turntable, With flush frame: It is possible to use high-lift as well as low-lift truck.	

	Wrapping type						
	A	B	C	D			
						It is forbidden to drive the high-lift truck on the turntable surface!	
5						Unroll the sufficient long piece of the film from prestretch device and fasten its end to the wrapped pallet (e.g. by latching to the pallet chock), or if the machine is equipped with the planette on the turntable, lock it in the planette.	
						During filling the film take care so that the film cannot get under the rotating part of the turntable anymore later during the wrapping; there is a risk of reeling of the film on the turntable chain and central bearing and eventually fall of the chain from the cog-wheel and from pinion.	
6						Put the machine into movement by press of the button START	
7						Set the necessary stretching of the film after the first revolution	
						Manual film brake: by turning the brake handle (see chapter 5.4.1)	
						Electromagnetic brake: by the controller on the panel (see chapters 5.4.3 and 5.5). During stretching of the film (the prestretch device is braking) the indicator lamp is glimmering.	
8						Reel several film layers on the bottom part of the pallet. Number of layers (reeling) adheres to the product kind and demands on wrapping firmness.	
						If the machine is equipped with frequency convertor for turntable drive, it is possible to set the speed of turntable rotation. You may regulate the rotation speed whenever during wrapping.	
9						Move the prestretch device upwards by the button for prestretch device travel upwards	
10						The prestretch device stops in the upper position after travelling across the pallet top of approximately 10÷15 cm. Reel several film layers on the upper part of the pallet.	
11						Move the prestretch device downwards for approximately 30 up to 40 cm – press the button for prestretch device travel downwards, the prestretch device start travelling and after passing of necessary track press this button once more – the prestretch device will stop	
12						Stop the machine turntable by pressing the button STOP	
13						Lay the overlapping film after total machine stop	
14						Put the turntable in movement by pressing the button START	

	Wrapping type					
	A	B	C	D		
15					Move the prestretch device upwards.	
16					The prestretch device will stop in the upper position. Reel several film layers around the upper pallet part.	
17					Move the prestretch device downwards to the bottom. Reel several film layers around the bottom pallet part.	
18					Stop the machine turntable by press of the button STOP	
19					After the turntable stop, cut the film and burnish its end to the wrapped goods.	
20					The prestretch device is in upper position. Move it into the bottom position.	
21					Remove the wrapped pallet	
22					Continue in point 3 or if you do not wrap another pallet, turn the machine off by the Main switch – controller to position "0".	

6.6. Modification of Parameters

Universal parameter values, which satisfy majority of the wrapped goods, are set by the producer. It is possible to modify the parameters, if necessary. The program as well as the individual parameters of the wrapping process may be modified when the machine is inactive as well as during wrapping; they will be applied in the following program start (in the following wrapping). The adjusted values are valid only for the mode, in which they were set (manual or automatic).

6.6.1. Procedure of Parameter Setting

Parameter of switchover of **SIMPLE/CROSS WRAPPING** has only two states, which are indicated by lighting indicator lamp by the relevant symbol. It has its function only in the automatic mode.

Other parameters may be modified by one of the following procedures (in the example there is mentioned the parameter of Speed of the prestretch device travel upwards, but the procedure is the same for all parameters with numerical value).

The machine must be in the mode, for which the parameter is adjusted (manual or automatic).

Modification of parameters – 1st variant:

Example: modification of speed of the prestretch device travel upwards

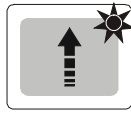

Press the button with parameter, which you want to modify. The indicator lamp lights up. In parameter Number of revolutions in the upper and bottom position press the button repeatedly until the indicator lamp at the appropriate parameter lights up. Parameter Speed of turntable rotation is not indicated.



Adjust the demanded value by buttons + and -. If you hold the button pressed, the value changes automatically



The new value is set without further confirmation and it is possible to adjust another parameter immediately. After last press of the button the parameter value is shown on the display for period of about of c. 30 s.

Modification of parameters – 2nd variant:

Example: change of the secondary prestretching from 70% to 210%



Selected parameter



It is lighting on the display



Press simultaneously buttons + and -



Number, which may be changed, is glimmering



With each simultaneous press of buttons + and - the cursor moves to the left position; if it is in the left end position, it will move to the first position (right end).



Press + or -. The value, on which the cursor is set will raised with one (when pressing button +) or it will decrease with one (when pressing button -). When passing between 9 and 0 also the upper digit place changes.



Press 1x

Saving parameters – automatic mode

The modified parameters automatically save during one of the three actions:

- By press of the button **START**, when the program saves and at the same time, its performance is started;
- By press of the button **+** or **-**, when the program saves and at the same time another program is selected;
- By press of the button for switching manual / automatic mode, when the program saves and at the same time the system switches to the manual mode

During saving of parameters display shows message **SAVE**. In this period the machine must not be turned off – there is a risk of damage of programs and system parameters of the machine.

Saving parameters – manual mode

The modified parameters automatically save by press of the button **START**, when the program saves and at the turntable is started.







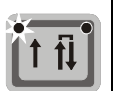

During saving of parameters display shows message **SAVE**. In this period the machine must not be turned off – there is a risk of damage of programs and system parameters of the machine.

6.6.2. Table of Parameters

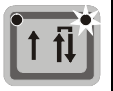
The table presents all variants which may be adjusted on the machine. In the table column Mode, there are stated modes, for which the setting has its meaning (A for automatic, H for manual).

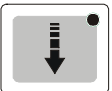
After testing the values of wrapping parameters, we recommend writing of the tested values in the table, which is in the end of these instructions for use. Thus you will make easier the repeated setting of the machine after repairs or system defects.

In the column Range, there is also stated the step of the parameter, which defines possible values, which the parameter may gain (e.g. if there is 0.5, 1, ..., 9.9, the parameter may gain values of 0.5; 1; 1.5; 2; 2.5 etc. up to 8.5; 9; 9.5; 9.9).

Parameter		Range		Production value		Mode
	Simple/cross wrapping		simple		cross	
			cross			
	Speed of the prestretch device travel upwards. The adjusted value affects the wrapping density. It is reached by interrupting the prestretch device travel.	10, 20, ..., 100 [%] (% of maximal speed)		100		A H
	Speed of the prestretch device travel downwards. The adjusted value affects the wrapping density. It is reached by interrupting the prestretch device travel.	10, 20, ..., 100 [%] (% of maximal speed)		100		A H
	Number of revolutions in the bottom position in the beginning of the wrapping. After running of these revolutions after the wrapping start, the prestretch device moves upwards	0.0, 0.1, ..., 9.9 [rev]		1		A
	Number of revolutions in the upper position After running of these revolutions the machine stops wrapping (in simple wrapping) or the prestretch device moves downwards (in cross wrapping)	0.0, 0.1, ..., 9.9 [rev]		1.5		A
	Secondary stretching of the film in the prestretch device. It is stated in percentage of the maximal brake force. This parameter is working only in machines which are equipped with the electromagnetic prestretch device	0, 10, ..., 100 [%]		50		A H
	Speed of turntable rotation. The parameter is working only when the turntable rotation is regulated by frequency convertor.	10, 20, ..., 100 [%]		100		A H

6.6.3. Notes

The specific setting of the machine, number of layers in the beginning and in the end of the wrapping, etc, depends on the wrapped goods and on their qualities, on demands on wrapping quality and level of goods protection, and on economic demands on the whole process.

6.7. Configuration Mode

The user may set the machine operation and program performance by the help of parameters in the configuration mode. There are two groups of parameters available for the user: system parameters and machine parameters.

System parameters are marked on the display with **P-** and these parameters immediately affect wrapping, its quality, speed and economy. They complete and specify the wrapping parameters, but they are only rarely set in practice.

Machine parameters are marked with **C-** on the display. These parameters are dependant on the machine configuration and on the used components. These parameters are changed only when the machine configuration is changed (e.g. use of different prestretch device, change of end switches, etc.). Only producer or supplying or service organization may interfere in these parameters. Access to these parameters is possible only via configuration mode of system parameters.

The following example describes the procedure during change of parameter P-1; parameter values are valid for this example, they may be different in your machine.

Setting of configuration mode of system parameter

After first pressing the code combination the mode of input scheme will show on the display – see parameter P-18.

The second press of the code combination invokes the configuration mode.

2x simultaneous press



The machine must be in manual mode. The indicator lamp on the button is lighted



Selecting of configuration mode



Parameter selection

Parameter numbers are shown on the display as numbers behind the letter **P** – **x**, the full list of parameters, their functions and values are stated in the parameter table in chapter 6.7.1.



The number of parameter, which may be changed, is lighting on the display



Selecting of number of the parameter, which needs to be changed



The number of parameter, which may be changed, is lighting on the display

Setting of the parameter value

Parameters cannot gain some values; their range and step are defined in parameter table in chapter 6.7.1. For instance, if there is stated 0,0.1,..., 25.5, in the table, the parameter may gain only values 0, 0.1, 0.2, 0.3 etc. (with step 0.1) up to 25.3, 25.4, 25.5. The allowable value is selected in the procedure according to the following example. Procedure for fast entering of the numeral value, mentioned in chapter 6.6, may be used even here.



The number of parameter, which may be changed, is lighting on the display

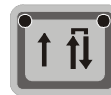

Switching parameter / value – switching to value editing



The current parameter value is lighting on the display



Selection of new parameter value by stepping in the list.



The new parameter value is lighting on the display

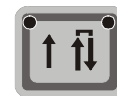

Switching parameter / value – switching back to parameter selection



The number of parameter, which may be changed, is lighting on the display

After switching back to the parameter selection, you may either select new parameter for editing or finish the configuration mode.

Setting of configuration mode of machine parameters

The machine must be in setting mode of configuration mode of the system parameters (see text above).

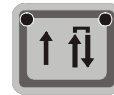

Set the password for access into the field of machine configuration parameters - parameter P-16 in the procedure according to the text above and according to chapter 6.6

For access into the field of configuration machine parameters, press combination of buttons



Number of machine parameter C- is lighting on the display

If, until now, the value of any of the system parameters has been changed these changes will be stored in the memory.

Finishing of configuration mode

Configuration mode will be finished by press of the button **SWITCHING OF AUTOMATIC AND MANUAL MODE**. After its press, the system asks whether the changed parameters shall be saved – notice **SAVE** shows on the display.

By pressing the button **SIMPLE / CROSS WRAPPING** the new parameter values will be saved in the store. After saving the parameters, system will quit the configuration mode.

The finishing procedure is the same for finishing of system parameters and for finishing of machine parameters.

Finishing of configuration mode with saving of parameters

Quitting of the configuration mode



Notice on the display

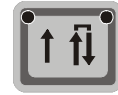

Simple / cross wrapping



The beeper sounds, parameters are saved into the store. During this period the machine must not be switched off, because if it is switched off in this period, the parameter data can be interfered



System quits the configuration mode, notice of manual mode is shown on the display

The system quits the configuration system without saving the changed parameters by press of any button. The new parameter values will not be saved either, if the machine is switched off before quitting the configuration mode.

Finishing of configuration mode without saving of parameters

Quitting of the configuration mode



Notice on the display



Any button, Except for simple/cross wrapping



System quits the configuration system without saving the parameters, notice of manual mode is shown on the display

Software release detection

Some parameters are dependant on the software release of the control system, which is used in your machine; a service engineer may request the number of

the software release during telephone consultation of the machine defect. The release number is saved in parameters P-34, P-35 and P-36 (this release number, which is valid for your machine at the moment of despatch from the producer, is mentioned in the appendix "Table of configuration parameters" in parameters P-34 to P-36).

Example: is used software release 1-23-45-67-8-9. The content of parameters is: P-34_= 123 ; P-35 = 4567; P-36_= 89.

6.7.1. System Configuration Parameters

All system parameters for fully equipped machine are stated. In case, that the machine is equipped with lower standard of the optional devices, the relevant parameters of these devices may be functionless. We recommend keeping their values in the values, which were set by producer. Note "determined for producer and service" is stated in some parameters. Do not change these parameters in any case.

Directed point (term in the text) – turntable position, which is taken by the sensor and to which some its functions are defined. By default, the directed point is the same as the point for directed stop, unless it is established otherwise in parameter P-10.

Values of the configuration parameters, which are set in your machine by the producer, are mentioned in the appendix "Table of configuration parameters". In case that your or service engineer interfere in these parameters, we recommend writing of the changes into this table; thus you will make easier the potential next service missions in the future.

No.	Description	Range	Unit of measure
P-0	Passage of the prestretch device above the upper edge of the pallet, i.e. overrun of the film above the upper edge of the pallet. It will secure good fixation of the upper edge of goods on the pallet. The adjusted value 5 corresponds to the upper edge of the wrapped goods, value over 5 is the demanded overrun. Unless the optical scanning of the pallet height is mounted on the machine, always set P-0=0.	0,1,...,100	cm
P-1	Number of revolutions after turntable start, for which the stretching is not adjusted, only after that the secondary stretching, which is set in the program, is used and the film is tightened around the goods. The parameter has its function for electromagnetic film brake. During these revolutions the eventual sharp edges of the goods will be covered with sufficient layers of the film, and during the follow-up wrapping with adjusted higher secondary prestretching the film will not be broken with sharp edges of the goods on the pallet.	0.1, 0.2, ..., 9.9	rev
P-2 to P-8	Reserve		

No.	Description	Range	Unit of measure
P-9	Minimal distance before the directed point of the turntable, in which the turntable does not manage to slow down to the stopping speed during directed stop. This parameter is determined to eliminate disturbance variables (motor slip, creeping, etc.). The parameter has its function only in machines equipped with frequency converter fore regulation of turntable revolutions.	0,1,...,180	°
P-10	Passage of turntable switch. During the directed stop turntable stops in this value behind the turntable switch. Increasing the value of this parameter decreases accuracy of the stop.	0,1,...,359	°
P-11	Speed in % of maximal speed, to which the turntable slows down during the directed stop and in which it then travels to the directed point. The parameter has its function only in machines equipped with frequency converter fore regulation of turntable revolutions.	1,2,...,50	%
P-12	Acceleration, or retardation of the turntable during speed changes. The lower this value is, the faster is the speed change of the turntable rotation and thus the impression on the wrapping machine and wrapped goods is also bigger. The parameter has its function only in machines equipped with frequency converter for regulation of turntable revolutions. In machines without turntable regulation by the converter it is adjusted to P-12=0.2	0.1, 0.2, ..., 9.9	s
P-13 to P-15	Reserve		
P-16	Entry gate into the field of machine configuration parameters C-x.	0,1,...,999	-
P-17	Reserve		
P-18	Displaying of input conditions. only for information. XXxx number of input couple (+ and - change) xxXX logical input values E.g. 001: DI0.0=0, DI0.1=1	-	-
P-19 to P-30	Reserve		
P-31	Max. turntable speed. Real turntable speed in revolutions per minute in maximal speed (100%). The parameter serves for internal system needs, its change does not affect the speed of turntable rotation and it can lead to unforeseen machine operation.	1.0, 2.0,...,20	1/min.
P-32	Maximal speed of the prestretch device travel along the mast.	100,...,999	cm/ min
P-33	reserve		
P-34	Software release, part 1 (see above)		
P-35	Software release, part 2 (see above)		
P-36	Software release, part 3 (see above)		

6.7.2. Machine Configuration Parameters

Some parameters are identified as Service parameters in the description. These parameters are determined purely for the producer or service organization and it is not possible to change them. For more information see chapter 6.7. Values of the configuration parameters such as they are set in your machine by the producer, are stated in the appendix "Table of configuration parameters".

No.	Description	Range	Unit of measure																
C-1	<p>Settings of types of the end switches DI0.0-DI0.8 (see the wiring scheme).</p> <p>1 – switching contact 0 – break contact, or the switch is not used</p> <p>Inputs are labelled with DI x.y – see the wiring scheme</p> <table style="width: 100%; border: none;"> <tr> <td>0 = 0000</td> <td>4 = 0100</td> <td>8 = 1000</td> <td>C = 1100</td> </tr> <tr> <td>1 = 0001</td> <td>5 = 0101</td> <td>9 = 1001</td> <td>D = 1101</td> </tr> <tr> <td>2 = 0010</td> <td>6 = 0110</td> <td>A = 1010</td> <td>E = 1110</td> </tr> <tr> <td>3 = 0011</td> <td>7 = 0111</td> <td>B = 1011</td> <td>F = 1111</td> </tr> </table> <p>E.g.: 0F=00001111: DI0.7=0, DI0.6=0, DI0.5=0, DI0.4=0, DI0.3=1, DI0.2=1, DI0.1=1, DI0.0=1,</p>	0 = 0000	4 = 0100	8 = 1000	C = 1100	1 = 0001	5 = 0101	9 = 1001	D = 1101	2 = 0010	6 = 0110	A = 1010	E = 1110	3 = 0011	7 = 0111	B = 1011	F = 1111	00 ... FF	-
0 = 0000	4 = 0100	8 = 1000	C = 1100																
1 = 0001	5 = 0101	9 = 1001	D = 1101																
2 = 0010	6 = 0110	A = 1010	E = 1110																
3 = 0011	7 = 0111	B = 1011	F = 1111																
C-2 to C-3	Reserve																		
C-4	Service parameter																		
C-5	<p>The first configuration word of the system.</p> <p>1xxx – the turntable drive is regulated by frequency convertor (it is possible to regulate fluently the turntable revolutions, exact directed stop)</p> <p>0xxx – the turntable drive is controlled by contactor or soft starter</p>	0000 ... 1111	-																
C-6	Reserve																		
C-7	<p>BROUT1 – output for the film brake.</p> <p>Parameters C7 ÷ C10 adjust the linearity of dependence of prestretch device intervention on the control system output.</p> <p>By default, the parameters C7 ÷ C10 are adjusted as follows from the production based on the producer's experience:</p> <table border="1" style="width: 100%; border-collapse: collapse;"> <thead> <tr> <th style="width: 30%;">Prestretch device</th> <th style="width: 10%;">C7</th> <th style="width: 10%;">C8</th> <th style="width: 10%;">C9</th> <th style="width: 10%;">C10</th> </tr> </thead> <tbody> <tr> <td>Electromagnetic film brake – default settings</td> <td style="text-align: center;">40</td> <td style="text-align: center;">70</td> <td style="text-align: center;">10</td> <td style="text-align: center;">60</td> </tr> <tr> <td>Electromagnetic film brake – softer characteristics</td> <td style="text-align: center;">0</td> <td style="text-align: center;">60</td> <td style="text-align: center;">0</td> <td style="text-align: center;">100</td> </tr> </tbody> </table> <p>Based on these settings the electromagnetic brake has stronger intervention from the beginning (it brakes more strongly) and this characteristic is then compared.</p>	Prestretch device	C7	C8	C9	C10	Electromagnetic film brake – default settings	40	70	10	60	Electromagnetic film brake – softer characteristics	0	60	0	100	0,1,..., 100	%	
Prestretch device	C7	C8	C9	C10															
Electromagnetic film brake – default settings	40	70	10	60															
Electromagnetic film brake – softer characteristics	0	60	0	100															
C-8	BROUT2 – output for the film brake. See parameter C-7	0,1,..., 100	%																
C-9	BRRIZ1 – force of the film brake (set on the display). See parameter C-7	0,1,..., 100	%																

No.	Description	Range	Unit of measure
C-10	BRRIZ2 – force of the film brake (set on the display). See parameter C-7	0,1,...,100	%
C-11 to C-14	Reserve		
C-15	Output of frequency converter of turntable – correction constant		
C-16 to C-18	Reserve		
C-19	If the value of this parameter is set to "1" the factory setting of the machine will be uploaded from the memory.	0, 1	-
C-20	Reset of error Errv – Changing of machine phases	0, 1	
C-21 to C-22			
C-23	Timeout of stretching device travel	0, 1, ..., 99	
C-24	Reserve		
C-25	Setting the number of wrapped pallets for request of service. For reading only. See chap. 6.9 for meaning. The displayed number should be multiplied by 100 (e.g. if the parameter C-25 displays number 126 the set number of pallets is 12 600). If this parameter is set to 0 the function for request of service is switched off.	0000 ... 9999	
C-26	Current number of wrapped pallets; if the number is equal or higher than C-25 the system will request service inspection. The displayed number should be multiplied by 100. See chap. 6.9		

6.8. Defects and Their Removals

The table presents some most frequent defects and failures, their causes and removals. These defects may be removed by staff or user's maintenance workers.

Defect	Cause	Removal
It is not possible to switch the machine on	Power supply, circuit breaker	
The machine is on and not working	Pressed button EMERGENCY STOP	See chapter 5.6.1
	Forklift-shaped turntable: shaded cutout sensor	Remove the obstruction, which shades the sensor in the cutout. Clean the sensor and the mirror. Check the sensor function. See chapter 7.1.8
Reverse running direction of the turntable and prestretch device	Power supply changed phases	See chapter 4.5
Running direction of the turntable is correct, running direction of the prestretch device is reverse	Belt on the winding drum of the prestretch device the drive along the mast is reeled reversely	In manual mode select the prestretch device travel upwards, in fact the prestretch device will travel downwards. After travelling in the bottom end position, the belt will start to reel on the drum in the correct direction.
The film tears	Unsuitable film	See chapter 2.6
	Sharp edges of the goods on pallet	Change the goods wrapping or decrease the secondary stretching (see chapter 5.4, 6.6)
	Too high secondary stretching	See chapter 5.4, 6.6
Unexpected machine operation	program	Check the selected program and its settings
	Unequal floor	Place the machine on braced floor (sensor geometry was interfered)
Hard machine operation	Machine overload	Respect the loading limit of the machine (see chapter 2.4 or commercial documentation)
	Reeled film on the turntable chain	Remove the film from the turntable chain (see chapter 7.1.4)
Unreliable scanning of the goods on turntable	Sensor orientation, it is not directed at the goods on the turntable.	Direct at the goods on the turntable

6.9. Error Messages on the Display

In case that the control voltage was disconnected by failure (the indicator lamp is off), it is necessary switch again the control voltage on after removal of the failure cause, by pressing the button **CONTROL VOLTAGE**.

If an error message occurs, the push-button **SWITCHING OF AUTOMATIC AND MANUAL MODE** will start blinking. Before going on, the error message should be confirmed by pressing the push-button **STOP**. Some errors can endure even after depressing the push-button **STOP** – in such case, the error message is not displayed but the push-button **SWITCHING OF AUTOMATIC AND MANUAL MODE** keeps blinking and the error message is displayed again after short time elapses or after any functional push-button in the display is depressed.

Display	Meaning	Removal
tStP	Pressed button EMERGENCY STOP	Remove the cause for pressing of the button EMERGENCY STOP . For next process see chapter 5.4.1
TIMV	timeout of prestretch device travel. Timeout of stretching device travel. Total time of motion in one direction (even interrupted) has exceeded the time set in parameter C-23. If the converter is used this time is weighted by the travel speed.	Failure of motor, belt, blocked travel of stretching device.
ErrV	The belt on the winding drum of the prestretch device the drive along the mast is reeled reversely.	In manual mode select the prestretch device travel upwards, in fact the prestretch device will travel downwards. After travelling in the bottom end position, the belt will start to reel on the drum in the correct direction.
	changed the supply phases	If the sense of the belt spooling is correct change the supply phases. After remedying the error, reset the error message by means of parameter C-20 – using the procedure according to chapter 6.7 set parameter C-20 to value 1 and store the parameters. After saving the parameter is the error reseted and value of parameter C-20 is 0 again.
E-No.	System damage occurred.	Request the producer or the service organization for repair.
SEr	Message of service request.	Number of wrapped pallets has exceeded the set number for service inspection. The message can be deleted by pressing the push-buttons "-" and CHANGEOVER OF SIMPLE / CROSS WRAPPING at the same time; the machine operation then goes on in the standard way; after another switching-on of control voltage by pressing the push-button Control voltage or after the machine has been idle for a longer period of time, the message appears again. Ask for preventative service inspection of the machine. See also parameters C-25 and C-26 (chap. 6.7.2)

7. MAINTENANCE AND CLEANING OF THE MACHINE

The wrapping machine demands regular maintenance. Respecting of this demand will be reflected in substantially longer period of service life of the whole machine. For correct check-up the pallet must not be placed on the turntable and film must not be filled in the prestretch device.

7.1. Maintenance of the Machine

Recommended cycles of acts	Act of maintenance
Every day	Clean the machine and its surroundings (chapter 7.1.4) check: entireness of the supply electric cables undamaged condition of foil keyboard move of the prestretch device and top-platen the over-all condition of the machine protective elements of the machine
Every 500 hrs. of operation or 1× in 3 months	Check-up of the belt fro prestretch drive travel
Every 1000 hrs. of operation or 1× in 6 months	Check-up of the turntable bearing (chapter 7.1.1) Check-up of the condition of turntable rollers (chapter 7.1.2) Check-up of the tension and lubrication of gear of the turntable with inter-gear (chapter 7.1.3)

Recommended cycles of the acts – according to what occurs earlier.

Recommended lubricant for lubrication of chains and turntable bearing: Mogul G3, Mogul LV2-3 or other grease with similar qualities.

7.1.1. Procedure for Check-Up of the Turntable Bearing

Standard turntable: loosen the screws on the turntable and lift the turntable. Loosen the chain stretcher and take off the big chain-wheel, the axis of which is laid in the turntable bearing. Check and eventually lubricate the bearing; mounting procedure is the reverse procedure.

Forklift-shaped turntable: take off the turntable cover and move the turntable so that one pulley is in the cutout, if it is not there. Mark the position of one of the springs, which push the pulleys to the turntable and loosen the spring. Take off the spring from the pin in the chain stretcher. Then it is possible to take the turntable itself from the base by upward traction (rotating part, on which the pallet is placed during wrapping). Check the bearings, lubricate the axial bearing, if necessary and eventually check the condition of turntable rollers (see chapter 7.1.2). The mounting procedure is reverse, take care so that the ball is in the central pin of the turntable; finally adjust the springs back to their original stretching.

7.1.2. Check-Up of the Turntable Rollers

Realize the check-up together with the check-up of the turntable bearing, when the turntable is taken off. The rollers must not have any deformations (flats or ruptures) and roller bearings must rotate fluently without any hint of irregular operation, scouring or inadequate difficulty of rotation. It is possible to order new rollers, if necessary; state the turntable diameter and loading limit of the machine (plastic or steel rollers) in the order. Bearing, which are used in the rollers, do not demand other maintenance or lubrication.

7.1.3. Check-Up of the Gear of Turntable with Inter-Gear

It is related to the turntable with inert-gear – the electrical motor of the turntable is hidden in the mast of the wrapping machine. The turntable drive is two-stage, where the first stage is V-belt and the second stage is a chain.

Realize the check-up of the belt and chain together with check-up of the central bearing (chapter 7.1.1) and rollers (chapter 7.1.2). Take off the turntable (for procedure see chapter 7.1.1) and cover between the mast and turntable (6x screw M5).

Check-up and tension of V-belt: Check the condition of the V-belt, if the upper layer is flaggy or the belt is warped or with broken rubber pieces, it is necessary to replace the belt with new belt of the same dimension and designation. V-belt must be tensioned correctly: when pressing with the force of 10 up to 20 N (1 up to 2 kg) in the middle between the sheaves, it shall drop for 10 up to 15 mm; the belt, which is tensioned too much, means bigger abrasion of the gear-box, bearings, belt and thus the shorter service life of the machine. If the sagging is bigger, it is necessary to tension the belt: take off the cover of the bottom part of the mast pos. 1 (it is fixed with four industrial Velcro fasteners and it could be dismantled by the consequent tension in the cover corners). Loosen screws M8 of the motor base pos. 2 (4x) and move the motor base in the slotted holes by turning of the screw shackle M10 pos. 3, thus you loosen or tension the belt as necessary, until you reach the prescribed value of the belt tension. Finally tighten the screws pos. 2 and cover the area.

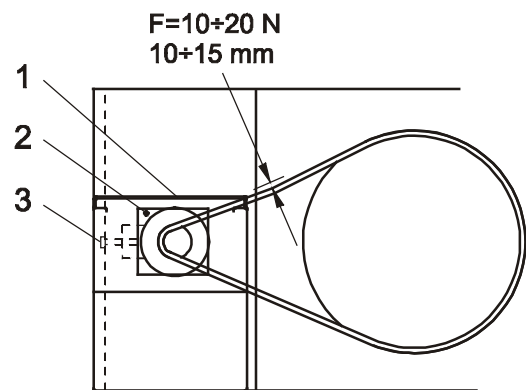

Check the V-belt also when unpleasant squeaky or scratchy sound occurs during start or stop; then gradually try all possibilities for its removal: smear the belt sides with soap; degrease inside (functional) parts of the sheaves and belt; tension the belt correctly.

The chain is tensioned by two stretchers, which are hauled by spring. In the case of falling of chain from chain-wheel, the chain is used-up and it must be replaced.

7.1.4. Repair of Turntable Chain

If the turntable suddenly does not rotate or if it rotates with difficulty and irregularly, the cause is mostly the film remainder reeled on the chain gearing of the turntable. In the extreme it may cause even the fall of chain from the cog-wheel or pinion.

Turntable except for forklift-shaped turntable: loosen the screws on the turntable and lift the turntable.

All turntable models: take off the cover between the mast and turntable; now the whole chain gearing is transparent.

Remove the film remainders and impurities from the chain, chain-wheel and pinion. Refill the lubricant grease if necessary. Clean also the whole area under the turntable and under the cover between the mast and turntable.

If the chain is fallen, then the repair procedure is depending on the turntable model:

Turntable except for forklift-shaped turntable: loosen the stretchers spring. If it is not possible to put the chain on the chain-wheel in such condition, it is necessary to unlink it and link it together again after it is put on the chain-wheel (the chain is always linked with chain coupler).

Forklift-shaped turntable: Loosen the spring of the tipping stretcher. Mark the position of the solid stretcher (it is fixed by screw in the forklift-shaped cutout) and loosen the screw, thus you will loosen the stretcher. Put the chain on the pinion and on as many teeth of chain-wheel as possible and you put the chain on the chain-wheel by manual turning of the V-belt wheel. Put the solid stretcher back into the original position and draw the screw close. Put the spring on the tipping stretcher.

After any work with turntable chain put the cover and metal plate of the turntable back and test the turntable operation by wrapping several pallets with advanced care.

7.1.5. Check-Up and Replacement of the Belt of the Prestretch Device Travel

Dismount the mast cover – screw out 4 × screws M5×12 with washers – and take off the cover. It is suitable, when one worker control the machine in the manual mode – moves the prestretch device along the whole mast height so that it is possible to check the condition of the belt in its total length – and the other worker realizes the check-up.



Check the belt only by sight – you must not touch the belt or any other moving part with hand during the check-up of the belt – there is a risk that your hand can be pulled in the mechanism of the prestretch device travel and also a risk of serious injury!

The belt must not have flaggy edge along its total length and it must not be torn. If it is damaged, it is necessary to replace the belt.

On the prestretch device truck the belt pos. 1 is pulled through the gap in the weldment pos. 2 between the wheel axis and the body of the truck. It is secured against unclamping by pulling the safety lock on pos. 3.

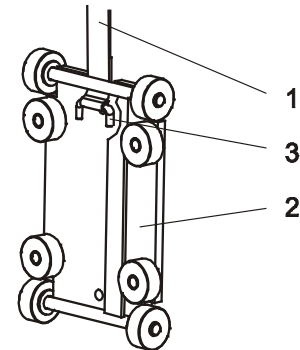

In the truck drive the belt reels on drum pos. 4. Screw out 2x screw M5x10 with washer – pos. 5, take out the drum front pos. 6 and pull the belt pos. 1 and the lock pin pos. 7 out from the drum slot pos. 4. The procedure for mounting is reverse.

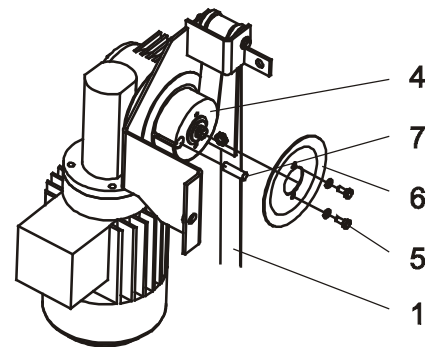

After check-up of the belt and its eventual replacement mount back the mast cover.

7.1.6. Maintenance of Mechanic Prestretch Device

For interval of check-up and lubrication of chain see chapter 7.1. If the film is filled in the prestretch device, it is necessary to remove it before the check-up and maintenance.

The chain of mechanic prestretch device must not be tensioned by force, then abrasion of chain-wheels and slacking of the chain occur. The chain shall drop for 1 up to max. 3 mm during soft tension (c. 5 N). If it is necessary to adjust the axes distance, act as follows:

The upper bearing of the main roll close to the mast is laid in the case in enlarged gaps. It is possible to move the upper bearing case after loosening the screws and thus adjust the correct chain sagging. Do not manipulate with the bottom bearing of the main roll, but slight deviation does not affect the functionality or reliability of the equipment. Then tighten the screws again.

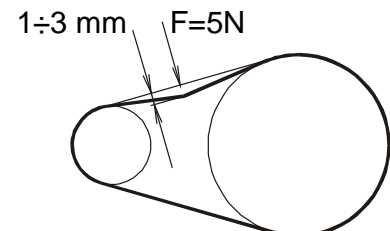

7.1.7. Maintenance of Electromagnetic Brake

It is related to machines, which are equipped with electromagnetic brake of the film

In case that the brake loses its efficiency, it is recommended to check and clean the working surfaces of the brake. If the bronze liner between the firm and movable parts of the brake is used-up, it must be replaced.

Dismounting of the brake: Screw out the cover of prestretch device and loosen the screw M 10 on the upper (movable) part of the brake. Take off the upper part of the brake, the pressure plate and friction liner. Mounting has a reverse procedure.

7.1.8. Sensor of Height of the Goods on Pallet

This sensor is placed on the prestretch device and it scans the height of the goods on pallet. After installation of new machine in the workplace check the position and orientation of the sensor of height of the goods on pallet. The sensor ray must be directed horizontally and in the top view it must direct at the turntable centre or max. 250 mm out of the centre (see the layout). If the sensor does not work reliably, check if its sight is not dirty, check the condition of supply cables and eventually the functionality of whole sensor (control LED diode is placed on the sensor, which is lighting when the sensor is shaded). It is possible to adjust the height of prestretch device travel above the upper edge of the goods on pallet.

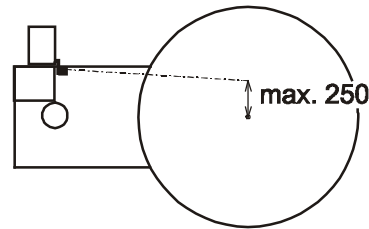

Adjusting of sensor on the manual film brake:

Loosen the screw pos. 1 and turn the arm with the sensor pos. 2 into the correct position according to text above. It is possible to adjust the prestretch device travel above the height of the goods on pallet by moving in the sleeve. Tighten the screw back.

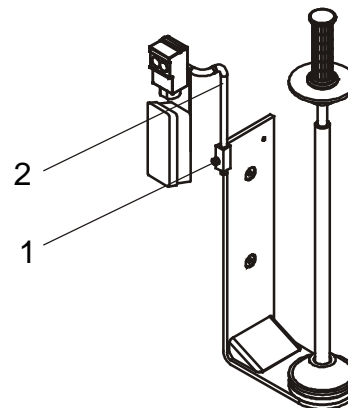

Adjusting of sensor on the electromagnetic film brake:

Orientation is given by the arm construction. If it is not satisfactory, loosen the screws pos. 3, take out the arm and modify it by bending or underlay it on the prestretch device. There are ports on the prestretch device pos. 4, which allow adjusting of prestretch device travel above the height of the goods on pallet.

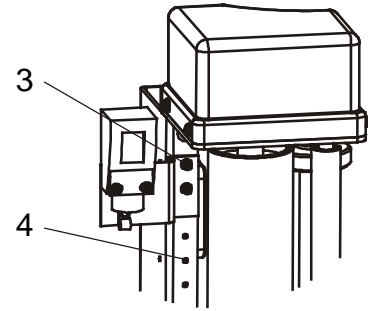

7.1.9. Maintenance of Wiring

As for maintenance of wiring it is necessary to keep the provisions of chapter 3.2 about qualification of the worker, who realizes the maintenance.

Before manipulation on the contactor switchboard and during other work with electric equipment, it is necessary to turn the **MAIN SWITCH** off and lock it; the key must be taken out from the lock.

During big repairs disconnect **electrical power supply** for the machine by unplugging of the supply cable from the socket!

The electric equipment demands planned and regular maintenance. When you respect this demand, it will be reflected in substantially longer service time of the wiring. In short intervals it is necessary to remove dust and impurities from the area of the electric equipment as well as from all devices. In longer intervals we draw close all screwed joints and contactors points, especially after serious short circuits. We also check the function of thermal protections, insulation, zeroising, eventually grounding.

Before each work on motors, it is necessary to turn the main switch off!

If the motor is not active for long time, it is necessary to check its condition, especially:

- If there is no obvious damage in any of its parts
- Winding insulation
- Conditions of motor bearings (after long period it is necessary to replace the grease packing)

7.1.10. Replacement of Damaged Keyboard

If the foil keyboard is damaged (breaking of the plastic foil, some keys are functionless or malfunctional), replace the keyboard.

Dismount the switchboard cover, on which the keyboard is glued. For easier manipulation it is possible to turn the cover outside with the internal side and screw it to the mast so that it is accessible from both sides (the cover overreaches the mast shape).

The keyboard is connected to the system via flat strip conductor. Pull the conductor out of the connector on the board of the control system.

The keyboard is glued to the switchboard cover by self-adhesive layer. Peel the old keyboard off, remove the remainder of the glue carefully from the metal plate (e.g. by petrol).

Peel the covering paper out of the new keyboard, insert the strip conductor via the opening in the cover and glue the keyboard to the original place. The display window must cover the system display.

For easier manipulation we recommend damp the base by the help of water sprayer with small quantity of soaking agent (detergent) during foil gluing. Then it is possible to slightly move the foil and thus modify the precise position. Then push water out by the rubber roller (for photographers).

Insert the strip conductor in the connector. Close the cover. Switch the machine on and test the function of new keyboard.

7.1.11.Note

Dates of check-ups and repairs, which are mentioned in this material by the producer, even their scope may be put more precisely on the basis of experience from the operation and from machine tests at producer's and at user's.

7.2. Ordering of Spare Parts

When ordering spare parts, always state the operational voltage and frequency; furthermore state the number of wiring scheme and marking of the machine in the scheme.

7.3. Cleaning

In short intervals it is necessary to remove dust and impurities. Remove continuously subjects and raw impurities, which may affect adversely the machine operation (rest of films, rest of broken pallets and goods, thrown subjects, etc.) every day.

It is possible to wash the machine surface with water and common detergents (the machine must be disconnected from the electrical network).

8. GUARANTEE

The general guarantee conditions are defined in the guarantee certificate, which is an inseparable part of the documentation delivered with the machine. The certificate of guarantee must be properly and completely filled-in and confirmed by the producer.

The guarantee condition is regular check-up and maintenance of the machine, complying with the instructions for use and use of original spare parts only.

The guarantee does not apply to defects caused by incorrect manipulation, violation of the instruction for use for the product, if an interference with the product was realized by unauthorized person (organization) and if the product was overloaded.

The guarantee also does not apply to defects caused natural wear of the machine parts.

8.1. User's Obligations

The user is obliged to provide only workers competent in health and physical state and provably familiarized with the instructions for use and maintenance and safety rules for the machine operation.

9. SERVICE

Repairs in guaranteed period and after-guaranteed period are realized by the producer. He/she also supplies the separate spare parts on the basis of consumer's order.

Producer's address: PRAGOMETAL spol. s r.o.
Víteňská 172
252 42 Jesenice u Prahy









Telephone: +420-234 144 746, 790

Fax: +420-234 144 710, 777

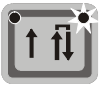

e-mail: servis@pragometal.com

<i>Document</i>	<i>WS_ECONOMIC-OBB_LGA_GB.doc</i>
<i>Date</i>	<i>11/2010</i>

Parameters of automatic wrapping program

Parameter	Range	A-1	A-2
			
			
	10, 20, ..., 100 [%]		
	10, 20, ..., 100 [%]		
	0.0, 0.1, ..., 9.9 [rev]		
	0.0, 0.1, ..., 9.9 [rev]		
	0, 10, ..., 100 [%]		
	10, 20, ..., 100 [%]		

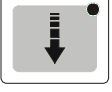
Parameters of manual mode

Parameter	Range	
	10, 20, ..., 100 [%]	
	10, 20, ..., 100 [%]	
	0, 10, ..., 100 [%]	
	10, 20, ..., 100 [%]	